



Fiber Reinforced Composite Bearings

HIGH LOAD SELF-LUBRICATING BEARINGS





Pushing Boundaries to co-create a higher Quality of Life

GGB works to push the boundaries of possibility, inspiring customers across all markets to partner—and innovate—alongside us. We help create a world of motion with minimal frictional loss through plain bearing, coating, and surface engineering technologies. With R&D, testing and production facilities in the United States, Germany, France, Brazil, Slovakia and China, GGB partners with customers worldwide on customized tribological design solutions that are efficient and environmentally sustainable. GGB's engineers bring their expertise and passion to a wide range of industries, including automotive, aerospace and industrial manufacturing. To learn more about GGB's surface engineering, visit www.ggbearings.com. <https://www.ggbearings.com/en>

Our products are used in tens of thousands of critical applications every day on our planet. It is always our goal to provide superior, high-quality solutions for our customers' needs, no matter where those demands take our products. From space vehicles to golf carts and virtually everything in between; we offer the industry's most extensive range of high performance, maintenance-free bearing solutions for a multitude of applications:

- [Aerospace](#)
- [Agricultural](#)
- [Automotive](#)
- [Construction](#)
- [E-Mobility](#)
- [Energy](#)
- [Fluid Power](#)
- [Industrial](#)
- [Medical](#)
- [Mining](#)
- [Oil & Gas](#)
- [Primary Metals](#)
- [Railway](#)
- [Recreation](#)

GGB - Who We Are

AT GGB, WE AREN'T AFRAID TO TAKE RISKS FOR OUR CUSTOMERS.

We are passionate about the work we do and believe that same passion contributes to the level of innovation that can enhance human potential. We take pride in working closely with customers in the early stage of a design to think broadly and boldly, and to expand beyond traditional surface engineered solutions. We offer reliable partnerships based on trust, compassion, determination, collaboration and respect.

As the tribological leader, GGB helps create a world of motion with minimal frictional loss through plain bearing and surface engineering technologies. Thanks to our global footprint and wealth of specific applications expertise, our capabilities are virtually limitless. We work to push the boundaries of possibility, inspiring customers across all markets to partner - and innovate - alongside us.



The GGB Advantage



LOWER SYSTEM COST

GGB bearings reduce shaft costs by eliminating the need for hardening and machining grease paths. Their compact, one-piece construction provides space and weight savings and simplifies assembly.



LOW-FRICTION, HIGH WEAR RESISTANCE

Low coefficients of friction eliminate the need for lubrication, while providing smooth operation, reducing wear and extending service life. Low-friction also eliminates the effects of stick-slip or "stiction" during start up.



MAINTENANCE-FREE

GGB bearings are self-lubricating, making them ideal for applications requiring long bearing life without continuous maintenance, as well as operating conditions with inadequate or no lubrication.



ENVIRONMENTAL

Greaseless, lead-free GGB bearings comply with increasingly stringent environmental regulations such as the EU RoHS directive restricting the use of hazardous substances in certain types of electrical and electronic equipment.



CUSTOMER SUPPORT

GGB's flexible production platform and extensive supply network assure quick turnaround and timely deliveries. In addition, we offer local applications engineering and technical support.

The Highest Standards in Quality



SAFETY

Our deep-rooted culture of safety places a relentless focus on creating a secure, healthy work environment for all. As one of our core values, safety is essential for us to achieve our goal of having the safest employees in the industry.



EXCELLENCE

Our world-class manufacturing plants in the United States, Brazil, China, Germany, France, and Slovakia are certified in quality and excellence according to ISO 9001, IATF 16949, ISO 14001, ISO 45001, and AS9100D/EN9100. This allows us to access the industry's best practices while aligning our management system with global standards.

For a complete listing of our certifications, please visit our website:

<https://www.ggbearings.com/en/certificates>



RESPECT

Our teams work together with mutual respect regardless of background, nationality, or function, embracing the diversity of people and learning from one another - after all, with respect comes both individual and group growth.

Table of Contents

1 Introduction	7	4.7 Operating Clearances	28
1.1 General Characteristics and Advantages	7	4.8 Dimensional Considerations	28
Wide Application Range	8	Wall Thickness	28
Low Friction Operation	8	Clearance	28
Wide Product Range of Sizes and Shapes	8	Bearing Length	28
2 Product Descriptions	9	4.9 Shaft Material and Surface Finish	29
GAR-MAX®	9	4.10 Housing Material	29
GAR-FIL®	10	4.11 Lubrication	29
HSG	11	4.12 Multifil Bearing Tape Design Features	30
MLG	12	Design Features	30
HPM	13	Rapid, Easy Installation	31
HPMB®	14	5 Performance	32
HPF®	15	5.1 Design Factors	32
GGB-MEGALIFE™ XT	16	5.2 Specific Load, p	32
Multifil	17	5.3 Sliding Speed, U	33
2.1 Performance Comparison Chart	18	5.4 pU Factor	33
3 Properties	19	5.5 Estimating Bearing Life	34
3.1 Physical Properties	19	Cyclic Bearing Life, L_Q	34
High Load Capacity Without Lubrication	19	High Load Factor, a_E	34
Wide Operating Temperature Range	19	Temperature Factor a_T	36
Weight Savings	19	Mating Material Factor - a_M	36
3.2 Performance Comparison	20	Mating Surface Factor - a_S	37
3.3 Chemical Resistance	21	Bearing Size Factor - a_B	37
4 Data for Designers	24	5.6 Worked Examples	38
4.1 Wear Rate	24	GAR-MAX®	38
4.2 Frictional Properties	25	GAR-FIL®	39
4.3 Operating Temperature	26	HPMB®	40
4.4 Load Capacity	26	MLG	41
4.5 Surface Velocity	27		
4.6 pU Factor	27		

Table of Contents

6 Misalignment	42	8 Standard Products	
7 Installation and Machining	44	8.1 GAR-FIL[®], GAR-MAX[®], HSG, MLG (Inch Sizes)	46
7.1 Installation	44	8.2 GAR-FIL[®], GAR-MAX[®], HSG, MLG (Metric Sizes)	50
7.2 Machining of HPMB[®] Bearings	44	8.3 European GAR-MAX[®] Size Range	54
7.3 Fitting	45	8.4 GGB-MEGALIFE[™] XT Thrust Washers (Inch Sizes)	56
Length	45	8.5 GGB-MEGALIFE[™] XT Thrust Washers (Metric Sizes)	57
Outer Diameter	45	9 Datasheet	58
Inner Diameter	45	Formula Symbols and Designations	59
Deburring	45	10 Other GGB Bearing Products	60
Drilling	45	11 Product Information	62
		RoHS - Restriction of Hazardous Substances	63



1 Introduction

The purpose of this handbook is to provide comprehensive technical information on the characteristics of GGB's family of fiber reinforced composite bearings, high load, self-lubricating bearings. The information given permits designers to establish the appropriate product required for a particular application. GGB's applications and development engineering services are available to offer solutions for bearings working under unusual operating conditions and/or requiring special designs.

GGB is the world's largest manufacturer of plain bearings for low maintenance and maintenance free applications. This includes an extensive product portfolio including metal-polymer bearings, injection moulded thermoplastic bearings, fiber reinforced composite bearings and metal and bimetal bearings.

GGB has manufacturing facilities world wide, and has remained the foremost supplier of self-lubricating plain bearings to the world's industrial and automotive markets for a long time. GGB is continually refining and extending its experimental and theoretical knowledge and, therefore, when using this brochure it is always worthwhile to contact GGB if additional information should be required.

As it is impossible to cover all conditions of operation that arise in practice, customers are advised to conduct prototype testing wherever possible.

1.1 GENERAL CHARACTERISTICS AND ADVANTAGES

To meet the need for high load, self-lubricating bearings that provide low wear rates in a wide variety of applications, GGB has developed a comprehensive family of fiber reinforced, composite self-lubricating bearing products. These bearings combine the excellent lubricating properties of filled PTFE (polytetrafluoroethylene) with the high strength and stability of an oriented glass fiber wound structure.

GGB's fiber reinforced composite bearings employ a tough, high strength composite structure consisting of epoxy-impregnated, wound glass fibers oriented to provide the radial and axial strength required to support high bearing loads.

GAR-MAX® and **HSG (High Strength GAR-MAX®)** Surface liner of PTFE and high strength fibers twisted together and encapsulated by a high temperature epoxy resin that has been further enhanced with a self-lubricating additive.

GAR-FIL® Proprietary filled PTFE tape liner bonded to the backing.

MLG Surface liner of PTFE and high strength fibers twisted together and encapsulated by a high temperature resin.

HPM Surface liner of PTFE and high strength fibers twisted together and encapsulated by a high temperature epoxy resin that has been further enhanced with PTFE.

HPMB® Surface liner of PTFE and high strength fibers twisted together and encapsulated by a high temperature epoxy resin that has been further enhanced with PTFE and other additives. The liner is easily machinable with a single point tool, either by GGB or by the customer prior to or post installation.

HPF® Surface liner consisting of a proprietary filled PTFE tape liner bonded to the backing.

GGB-MEGALIFE™ XT Thrust washers have a proprietary filled PTFE surface on both sides of the washers supported by a high strength composite inner core.

Multifil Tape bearing product has PTFE tape with proprietary fillers that can be easily bonded to any substrate.

Wide Application Range

Laboratory and field testing have proven that GGB fiber reinforced composite bearings provide outstanding performance in a wide variety of demanding dry or lubricated bearing applications. These include:

- Construction equipment
- Agricultural equipment
- Aerial lifts
- Railroad applications
- Materials handling
- Processing equipment
- Snowmobile and ATV CVT clutches
- Water turbines
- Waste and recycling equipment
- Packing equipment, and many more.

Low Friction Operation

GGB self-lubricating fiber reinforced composite bearings are particularly effective in applications where the relative motion is not sufficient to promote circulation of the oil or grease used with more conventional bearings. The natural lubricity of the PTFE encapsulated in the fiber reinforced composite bearing surface assures low friction in dry applications. In fact, in low speed, high pressure type applications, GAR-FIL® and HPMB® bearings offer one of the lowest coefficients of friction of any self-lubricated bearing product.

Wide Range of Sizes and Shapes

GGB fiber reinforced composite bearings are available in standard sizes from 12 mm to 150 mm [1/2" to 6"] ID with wall thicknesses of 2.5 mm and 5 mm [1/8" and 1/4"], including lengths up to 400 mm [16"].

On special order, ID sizes from 10 mm to over 500 mm [3/8" to over 20"] can be furnished with custom wall thickness and/or length as required.

GGB-MEGALIFE™ XT thrust washers are available in standard sizes with custom sizes available upon request.

Multifil bearing tape is available in thicknesses 0.38 mm [0.015"], 0.76 mm [0.030"], 1.14 mm [0.045"], 1.52 mm [0.060"], 2.29 mm [0.090"] and 3.18 mm [0.125"] and widths 305 mm [12.0"] and 610 mm [24.0"].

Special shapes based on customer requirements are possible as shown below. Contact GGB for details.

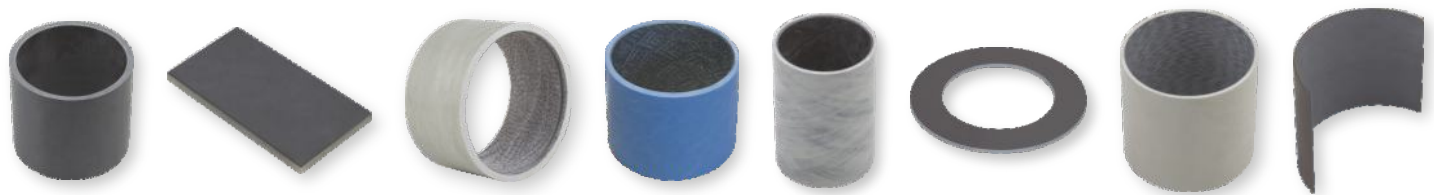

Fig. 1: Standard Shapes



Fig. 2: Examples of Special Shapes

2 Product Descriptions

GAR-MAX[®]

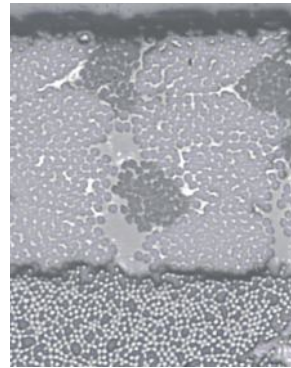

Sliding layer
Continuous wound PTFE and high-strength fibers encapsulated in an internally lubricated, high temperature filled epoxy resin.

Backing
Continuous wound fiberglass encapsulated in high temperature epoxy resin

CHARACTERISTICS

- High load capacity
- Excellent shock and misalignment resistance
- Excellent contamination resistance
- Very good friction and wear properties
- Good chemical resistance

POSSIBLE APPLICATIONS

- Steering linkages
- Hydraulic cylinder pivots
- King pin bearings
- Boom lifts, scissor lifts
- Cranes, hoists, lift gates
- Backhoes, trenchers
- Skid steer loaders
- Front end loaders

AVAILABILITY

Standard

- Plain cylindrical bushes
Inner diameter range:
Metric: 12 - 150 mm
Standard: 1/2 - 6"

Special order

- Plain cylindrical bushes
Inner diameter range:
Metric: 10 - 500 mm
Standard: 3/8 - 20"
- Customized bushing designs
- Cylindrical bushes with non-standard lengths and wall thickness, flanged bearings, hexagonal and square bores, liner on outer diameter

BEARING PROPERTIES	METRIC	IMPERIAL
Ultimate compressive strength σ_c	414 N/mm ²	60 000 psi
Maximum static load $p_{sta,max}$	210 N/mm ²	30 000 psi
Maximum dynamic load $p_{dyn,max}$	140 N/mm ²	20 000 psi
Maximum sliding speed U	0.13 m/s	25 fpm
Maximum pU factor	1.05 N/mm ² x m/s	30 000 psi x fpm
Maximum temperature T_{max}	160 °C	320 °F
Minimum temperature T_{min}	- 195 °C	- 320 °F

2 Product Descriptions

GAR-FIL®

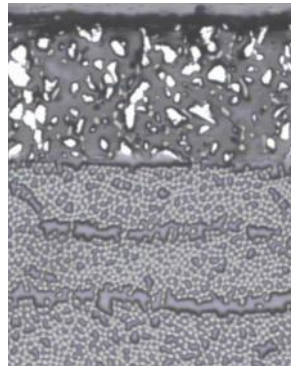

Sliding layer
Proprietary filled PTFE tape liner, 0.38 mm (.015") standard thickness (0.76mm (.030") available for machining)

Backing
Continuous wound fiberglass encapsulated in high temperature epoxy resin

CHARACTERISTICS

- High load capacity
- Good chemical resistance
- Machinable bearing surface
- High rotational speed capacity
- Very good friction and wear properties
- Excellent contamination resistance

POSSIBLE APPLICATIONS

- Valves
- Scissor lifts
- Pulleys
- Toggle linkages

AVAILABILITY

Standard

- Plain cylindrical bushes
Inner diameter range:
Metric: 12 - 150 mm
Standard: 1/2 - 6"

Special order

- Plain cylindrical bushes
Inner diameter range:
Metric: 10 - 500 mm
Standard: 3/8 - 20"
- Customized bushing designs
- Cylindrical bushes with non-standard lengths and wall thickness, flanged bearings, hexagonal and square bores, liner on outer diameter

BEARING PROPERTIES	METRIC	IMPERIAL
Ultimate compressive strength σ_c	379 N/mm ²	55 000 psi
Maximum static load $p_{sta,max}$	140 N/mm ²	20 000 psi
Maximum dynamic load $p_{dyn,max}$	140 N/mm ²	20 000 psi
Maximum sliding speed U	2.5 m/s	500 fpm
Maximum pU factor	1.23 N/mm ² x m/s	35 000 psi x fpm
Maximum temperature T_{max}	205 °C	400 °F
Minimum temperature T_{min}	- 195 °C	- 320 °F

HSG

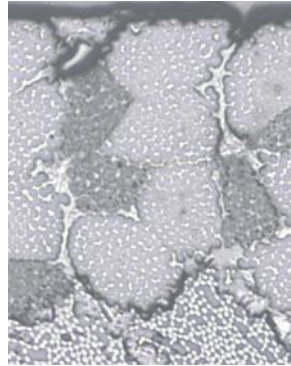

Sliding layer
Continuous wound PTFE and high-strength fibers encapsulated in an internally lubricated, high temperature filled epoxy resin.

Backing
Continuous wound fiberglass encapsulated in high temperature epoxy resin

CHARACTERISTICS

- High static load capacity - twice as high as standard GAR-MAX® bearings
- Excellent shock and misalignment resistance
- Excellent contamination resistance
- Very good friction and wear properties
- Good chemical resistance

POSSIBLE APPLICATIONS

- Steering linkages
- Hydraulic cylinder pivots
- King pin bearings
- Boom lifts, scissor lifts
- Cranes, hoists, lift gates
- Backhoes, trenchers
- Skid steer loaders
- Front end loaders

AVAILABILITY

Standard

- Plain cylindrical bushes
Inner diameter range:
Metric: 12 - 150 mm
Standard: 1/2 - 6"

Special order

- Plain cylindrical bushes
Inner diameter range:
Metric: 10 - 500 mm
Standard: 3/8 - 20"
- Customized bushing designs
- Cylindrical bushes with non-standard lengths and wall thickness, flanged bearings, hexagonal and square bores, liner on outer diameter

BEARING PROPERTIES	METRIC	IMPERIAL
Ultimate compressive strength σ_c	621 N/mm ²	90 000 psi
Maximum static load $p_{sta,max}$	415 N/mm ²	60 000 psi
Maximum dynamic load $p_{dyn,max}$	140 N/mm ²	20 000 psi
Maximum sliding speed U	0.13 m/s	25 fpm
Maximum pU factor	1.05 N/mm ² x m/s	30 000 psi x fpm
Maximum temperature T_{max}	160 °C	320 °F
Minimum temperature T_{min}	- 195 °C	- 320 °F

2 Product Descriptions

MLG

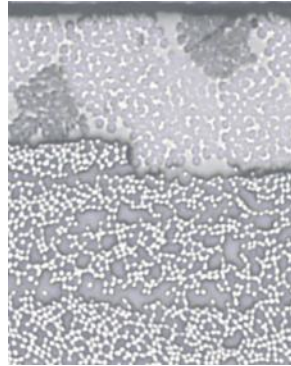

Sliding layer
Continuous wound PTFE and high-strength fibers encapsulated in high temperature filled epoxy resin.

Backing
Continuous wound fiberglass encapsulated in high temperature epoxy resin

CHARACTERISTICS

- Value engineered filament wound bearing for lighter duty applications
- High load capacity
- Good misalignment resistance
- Excellent shock resistance
- Good friction and wear properties
- Good chemical resistance

POSSIBLE APPLICATIONS

- Construction and earth moving equipment
- Conveyors
- Cranes and hoists
- Hydraulic cylinder pivots

AVAILABILITY

Standard

- Plain cylindrical bushes
Inner diameter range:
Metric: 12 - 150 mm
Standard: 1/2 - 6"

Special order

- Plain cylindrical bushes
Inner diameter range:
Metric: 10 - 500 mm
Standard: 3/8 - 20"
- Customized bushing designs
- Cylindrical bushes with non-standard lengths and wall thickness, flanged bearings, hexagonal and square bores, liner on outer diameter

BEARING PROPERTIES	METRIC	IMPERIAL
Ultimate compressive strength σ_c	414 N/mm ²	60 000 psi
Maximum static load $p_{sta,max}$	210 N/mm ²	30 000 psi
Maximum dynamic load $p_{dyn,max}$	140 N/mm ²	20 000 psi
Maximum sliding speed U	0.13 m/s	25 fpm
Maximum pU factor	1.05 N/mm ² x m/s	30 000 psi x fpm
Maximum temperature T_{max}	160 °C	320 °F
Minimum temperature T_{min}	- 195 °C	- 320 °F

HPM

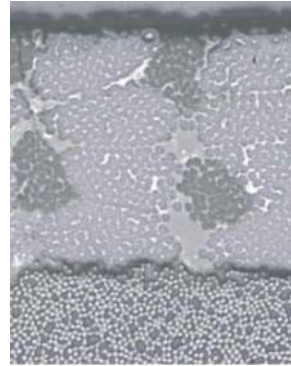

Sliding layer
Continuous wound PTFE and high-strength fibers encapsulated in a self-lubricating, high temperature epoxy resin
0.63 mm

Backing
Continuous wound fiberglass encapsulated in high temperature epoxy resin

CHARACTERISTICS

- Designed for hydropower applications
- High load capacity
- Excellent shock and edge loading capacity
- Low friction, superior wear rate and bearing life
- Excellent corrosion resistance
- Dimensional stability - very low water absorption, low swelling
- Environmentally friendly

POSSIBLE APPLICATIONS

- Servo-motor bearings
- Linkage bearings
- Wicket gate bearings
- Guide vane bearings
- Intake gate sliding segments
- Spillway gate bearings
- Trash rake bearings
- Fish screen bearings
- Trunnion bearings
- Blade bearings
- Injector bearings
- Delector bearings
- Ball and butterfly trunnion bearings

AVAILABILITY

Standard

- Plain cylindrical bushings

Special order

- Cylindrical bushes from 10 mm to 500 mm (20")
- customized bearing designs

BEARING PROPERTIES	METRIC	IMPERIAL
Ultimate compressive strength σ_c	345 N/mm ²	50 000 psi
Maximum static load $p_{sta,max}$	210 N/mm ²	30 000 psi
Maximum dynamic load $p_{dyn,max}$	140 N/mm ²	20 000 psi
Maximum sliding speed U	0.13 m/s	25 fpm
Maximum pU factor	1.23 N/mm ² x m/s	35 000 psi x fpm
Maximum temperature T_{max}	160 °C	320 °F
Minimum temperature T_{min}	- 195 °C	- 320 °F

2 Product Descriptions

HPMB®

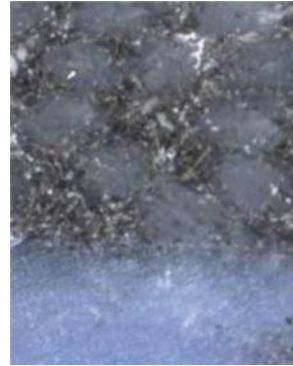
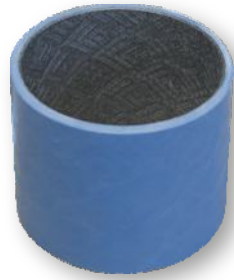

Sliding layer
Machinable continuous wound PTFE and high-strength fibers encapsulated in an internally lubricated, high temperature filled epoxy resin.

Backing
Continuous wound fiberglass encapsulated in high temperature epoxy resin

CHARACTERISTICS

- Machinable inner and outer diameters for superior application precision, circularity and cylindricity tolerances
- Pre-machined high precision HPMB bearings available for immediate installation
- High precision through easy single point machining of the bearing liner, on-site prior to installation
- Superior precision achieved with post-installation (inner diameter tolerance IT7 attainable) single point machining of the bearing liner
- High load capacity and excellent dithering performance
- Excellent shock and edge loading capacity
- Low friction with negligible stick-slip
- Low wear rate for extended bearing life
- Excellent corrosion resistance
- Dimensionally stable - very low water absorption, low swelling
- Environmentally friendly grease-free operation

POSSIBLE APPLICATIONS

- Steering linkages
- Hydraulic cylinder pivots
- King pin bearings
- Boom lifts, scissor lifts
- Cranes, hoists, lift gates
- Backhoes, trenchers
- Skid steer loaders
- Front end loaders
- Injection molding machines
- Railway applications
- Water turbines
- Valves

AVAILABILITY

Special order

- Finished cylindrical bushings, pre-machined cylindrical bushings, flanged cylindrical bushings (subject to design review)

BEARING PROPERTIES	METRIC	IMPERIAL
Ultimate compressive strength σ_c	414 N/mm ²	60 000 psi
Maximum static load $p_{sta,max}$	210 N/mm ²	30 000 psi
Maximum dynamic load $p_{dyn,max}$	140 N/mm ²	20 000 psi
Maximum sliding speed U	0.13 m/s	25 fpm
Maximum pU factor	1.23 N/mm ² x m/s	35 000 psi x fpm
Maximum temperature T_{max}	160 °C	320 °F
Minimum temperature T_{min}	- 195 °C	-320 °F

HPF®

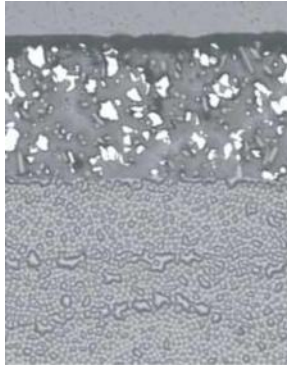

Sliding layer
Proprietary filled PTFE
tape liner

Backing
Continuous woven fiberglass
cloth laminate impregnated and
cured with epoxy resin

CHARACTERISTICS

- Designed for hydropower applications
- Machinable bearing surface
- High load capacity
- Low friction, superior wear rate and bearing life
- Excellent corrosion resistance
- Dimensional stability - very low water absorption, low swelling
- Environmentally friendly

POSSIBLE APPLICATIONS

- Servo-motor bearings
- Operating ring sliding segments
- Linkage bearings
- Wicket gate bearings
- Guide vane bearings
- Intake gate sliding segments
- Spillway gate bearings
- Trash rake bearings
- Fish screen bearings
- Trunnion bearings
- Blade bearings
- Injector bearings
- Delector bearings
- Ball and butterfly trunnion bearings

AVAILABILITY

Special order

- Cylindrical bearings, diameters up to 500 mm (20"); thrust bearings and sliding plates

BEARING PROPERTIES

BEARING PROPERTIES	METRIC	IMPERIAL
Ultimate compressive strength σ_c	379 N/mm ²	55 000 psi
Maximum static load $p_{sta,max}$	140 N/mm ²	20 000 psi
Maximum dynamic load $p_{dyn,max}$	140 N/mm ²	20 000 psi
Maximum sliding speed U	2.5 m/s	500 fpm
Maximum pU factor	1.23 N/mm ² x m/s	35 000 psi x fpm
Maximum temperature T_{max}	140 °C	285 °F
Minimum temperature T_{min}	- 195 °C	- 320 °F

2 Product Descriptions

GGB MEGALIFE^{XT} THRUST WASHERS

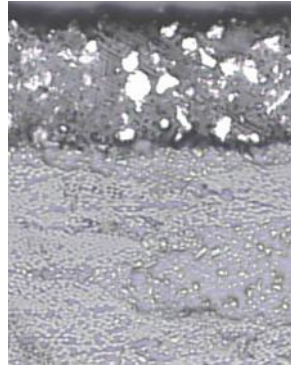

Sliding layer
Continuous wound PTFE
tape liner on both sides

Backing
Continuously woven layer of
filament fiberglass encapsulated
in a high temperature epoxy resin

CHARACTERISTICS

- Excellent shock resistance
- High load capacity
- Excellent misalignment resistance
- Excellent contamination resistance
- Good surface speed capability
- Very good friction and wear properties
- Good chemical resistance

POSSIBLE APPLICATIONS

- Pulley spacers
- Gear spacers
- Aerial lifts
- Fork lift masts
- King pins
- Steering links
- Lift gates
- Cranes
- Backhoes
- Valve actuator linkages

AVAILABILITY

Standard

- Thrust washers, standard sizes see pages 49-50

Special order

- Thrust washers with non-standard dimensions
- Customized bearing designs

BEARING PROPERTIES	METRIC	IMPERIAL
Ultimate compressive strength σ_c	207 N/mm ²	30 000 psi
Maximum static load $p_{sta,max}$	140 N/mm ²	20 000 psi
Maximum dynamic load $p_{dyn,max}$	140 N/mm ²	20 000 psi
Maximum sliding speed U	0.5 m/s	100 fpm
Maximum pU factor	1.23 N/mm ² x m/s	35 000 psi x fpm
Maximum temperature T_{max}	175 °C	350 °F
Minimum temperature T_{min}	- 195 °C	- 320 °F

MULTIFIL

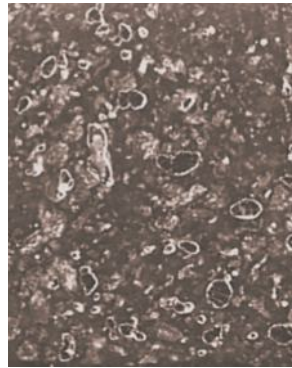

Structure -
PTFE tape with proprietary
filler system

CHARACTERISTICS

- Superior sliding bearing material which can be easily bonded to any clean, rigid substrate
- Reduces vibration

POSSIBLE APPLICATIONS

- Machined tool ways
- Sliding applications where bearing tape can be added on

AVAILABILITY

Standard

- Sliding plates, tape with 0.38 mm (0.015") to 3.2 mm (0.125") thickness and 305 mm (12") or 610 mm (24") width

BEARING PROPERTIES	METRIC	IMPERIAL
Ultimate compressive strength σ_c	140 N/mm ²	20 000 psi
Maximum static load $p_{sta,max}$	70 N/mm ²	10 000 psi
Maximum dynamic load $p_{dyn,max}$	35 N/mm ²	5 000 psi
Maximum sliding speed U	2.5 m/s	500 fpm
Maximum pU factor	0.32 N/mm ² x m/s	9 000 psi x fpm
Maximum temperature T_{max}	280 °C	540 °F
Minimum temperature T_{min}	- 200 °C	- 330 °F

2 Product Descriptions

2.1 PERFORMANCE COMPARISON CHART

BEARING PROPERTIES	LOAD CARRYING CAPABILITY	SHOCK LOADING RESISTANCE	SPEED CAPABILITY	CONTAMINATION RESISTANCE	MISALIGNMENT RESISTANCE	MACHINABILITY
GAR-MAX®	● ● ●	● ●	●	● ● ●	● ●	●
GAR-FIL®	● ● ●	●	● ● ●	● ●	●	● ● ●
HSG	● ● ●	● ● ●	●	● ● ●	● ● ●	●
MLG	● ● ●	● ●	●	● ●	●	●
HPM	● ● ●	● ●	●	● ● ●	● ●	●
HPMB®	● ● ●	● ●	●	● ● ●	● ●	● ● ●
HPF®, sliding plate	● ● ●	●	● ● ●	● ●	●	● ● ●
HPF®, cylindrical bearing	● ● ●	●	● ● ●	● ●	●	● ● ●
GGB Megalife™ XT	● ●	●	● ●	● ●	●	● ●
Multifil	●	●	● ● ●	● ●	● ●	● ● ●

Table 1: Performance comparison chart

● ● ● Excellent ● ● Good ● Fair ● Not recommended

3 Properties

3.1 PHYSICAL PROPERTIES

Table 2 shows the physical properties of GGB's fiber reinforced composite bearings.

High Load Capacity Without Lubrication

The ultimate compressive strength and maximum dynamic capacity of GGB fiber reinforced composite bearings without lubrication exceed those of most other conventional/traditional bearing materials with lubrication.

Wide Operating Temperature Range

GGB fiber reinforced composite bearings can operate at much higher temperatures than lubricated bearings. This opens new application opportunities where metallic bearings cannot function because of the limited temperature range of most greases and oils.

Weight Savings

GGB fiber reinforced composite bearings are 75% lighter than similarly sized bronze or steel bearings. This can result in a substantial weight saving, especially with larger bearings.

PHYSICAL PROPERTIES	UNITS	GAR-MAX®	GAR-FIL®	HSG	MLG	HPM	HPMB®	HPF® Sliding Plates	GGB MEGALIFE™XT	Multifil
Ultimate Compressive Strength	N/mm ²	414	379	621	414	345	414**	379	207	-
	psi	60 000	55 000	90 000	60 000	50 000	60 000	55 000	30 000	-
Static Load Capacity	N/mm ²	210	140	415	210	210	210	140	140	70
	psi	30 000	20 000	60 000	30 000	20 000	30 000	20 000	20 000	10 000
Maximum Dynamic Load Capacity	N/mm ²	140	140	140	140	140	140	140	140	35
	psi	20 000	20 000	20 000	20 000	20 000	20 000	20 000	20 000	5 000
Maximum Relative Surface Speed	m/s	0.13	2.5	0.13	0.13	0.13	0.13	2.5	0.5	2.5
	fpm	25	500	25	25	25	25	500	100	500
Maximum pU Factor	N/mm ² x m/s	1.05	1.23	1.05	1.05	1.23	1.23	1.23	1.23	0.32
	psi x fpm	30 000	35 000	30 000	30 000	35 000	35 000	35 000	35 000	9 000
Maximum Operating Temperature	°C	160	205	160	160	160	160	140	175	280
	°F	320	400	320	320	320	320	285	350	540
Minimum Operating Temperature	°C	-195	-195	-195	-195	-195	-195	-195	-195	-200
	°F	-320	-320	-320	-320	-320	-320	-320	-320	-330
Thermal Expansion Rate - Hoop	10 ⁻⁶ /K	12.6	12.6	12.6	12.6	12.6	12.6	10.8*	12.6*	-
	10 ⁻⁶ /F	7.0	7.0	7.0	7.0	7.0	7.0	6.0*	7.0*	-
Thermal Expansion Rate - Axial	10 ⁻⁶ /K	27.0	27.0	27.0	27.0	27.0	27.0	-	-	-
	10 ⁻⁶ /F	15.0	15.0	15.0	15.0	15.0	15.0	-	-	-
Specific Gravity	-	1.87	1.96	1.87	1.87	1.87	1.87	1.90	1.85	2.37

Table 2: Physical properties of GGB fiber reinforced composite bearings

* Lengthwise ** For details contact GGB Applications Engineering department

3 Properties

3.2 PERFORMANCE COMPARISON

Table 3 presents the properties information in a convenient table to help you choose the best product for your application.

MATERIAL	MAXIMUM DYNAMIC CAPACITY [<0.025 m/s (5 sft/Min)]		MAXIMUM TEMPERATURE		THERMAL EXPANSION RATE - HOOP		SPECIFIC GRAVITY
	N/mm ²	psi	°C	°F	10 ⁻⁶ /K	10 ⁻⁶ /°F	
Cast Bronze*	41	6 000	71	160	18.0	10	8.80
Porous Bronze**	28	4 000	71	160	18.0	10	7.50
Alloyed Bronze*	69	10 000	93	200	28.8	16	8.10
Steel-Backed Bronze*	24	3 500	93	200	14.4	8	8.00
Hardened Steel*	276	40 000	93	200	12.6	7	7.90
Zinc Aluminum*	38	5 500	93	200	27.0	15	5.00
Fabric-Reinforced Phenolic*	41	6 000	93	200	36.0	20	1.60
Reinforced PTFE	14	2 000	260	500	99.0	55	2.00
GAR-MAX®	140	20 000	160	320	12.6	7	1.87
GAR-FIL®	140	20000	205	400	12.6	7	1.96
HSG	140	20 000	160	320	12.6	7	1.87
MLG	140	20 000	160	325	12.6	7	1.87
HPM	40	20 000	160	320	12.6	7	1.87
HPMB®	140	20 000	160	325	12.6	7	1.87
HPF®, Sliding Plate	140	20 000	140	285	10.8***	6***	1.90
GGB MEGALIFE™ XT	140	20 000	175	350	12.6***	7***	1.85
MULTIFIL	35	5 000	280	540	-	-	2.37

Table 3: Comparison of various bearing materials

* With lubrication; ** Oil impregnated; *** Lengthwise

Note

Actual performance depends on the interaction of many parameters that may vary with the specific application. For example, maximum values listed for loads, speeds and temperature cannot be used simultaneously. However, in certain applications, individual values can be exceeded. For conditions that do exceed the recommended design limits, contact our Engineering Department.

3.3 CHEMICAL RESISTANCE

GGB's fiber reinforced composite bearings are resistant to a wide variety of chemicals including acids, bases, salt solutions, oils, fuels, alcohols, solvents and gases.

GGB's fiber reinforced composite bearings offer greater chemical resistance than metallic bearings. In particular, GAR-FIL® is resistant to the greatest number of chemicals, and is used in a wide range of valves employed in the chemical processing industry as well as for fire-safe valves.

The chemical resistance of GGB's fiber reinforced composite bearings to many common chemicals at 70 °F is shown in Table 4.

We recommend conducting a chemical resistance test prior to specifying a bearing that will be exposed to a chemical. An effective test (ASTM D 543) is to submerge a sample bearing in the subject chemical at the maximum anticipated operating temperature for seven days. If there is a change in the weight, dimensions, or compressive strength of the bearing, then the bearing is not resistant to the chemical.

CHEMICAL	GAR-MAX®	GAR-FIL®	HSG	MLG	HPM/HPMB®	HPF®/GGB MEGALIFE™ XT	Multifil
Acids 10%							
Acetic	Yes	Yes	Yes	Yes	Yes	Yes	No
Arsenic	No	Yes	No	No	No	Yes	Yes
Boric	Yes	Yes	Yes	Yes	es	Yes	Yes
Carbonic	No	No	No	No	No	No	No
Citric	Yes	Yes	Yes	Yes	Yes	Yes	Yes
Hydrochloric	Yes	Yes	Yes	Yes	Yes	Yes	No
Hydro-fluoric	No	No	No	No	No	No	No
Nitric	No	No	No	No	No	No	No
Sulfuric	Yes	Yes	Yes	Yes	Yes	Yes	Yes
Bases 10%							
Aluminum Hydroxide	Yes	Yes	Yes	Yes	Yes	Yes	Yes
Calcium Hydroxide	Yes	Yes	Yes	Yes	Yes	Yes	Yes
Magnesium Hydroxide	Yes	Yes	Yes	Yes	Yes	Yes	Yes
Potassium Hydroxide	Yes	Yes	Yes	Yes	Yes	Yes	Yes
Sodium Hydroxide	Yes	Yes	Yes	Yes	Yes	Yes	Yes
Salts							
Aluminum Chloride	Yes	Yes	Yes	Yes	Yes	Yes	Yes
Aluminum Nitrate	Yes	Yes	Yes	Yes	Yes	Yes	Yes
Aluminum Sulfate	Yes	Yes	Yes	Yes	Yes	Yes	Yes
Calcium Chloride	Yes	Yes	Yes	Yes	Yes	Yes	Yes
Ferric Chloride	Yes	Yes	Yes	Yes	Yes	Yes	Yes
Magnesium Carbonate	Yes	Yes	Yes	Yes	Yes	Yes	Yes
Magnesium Chloride	Yes	Yes	Yes	Yes	Yes	Yes	Yes
Magnesium Sulfate	Yes	Yes	Yes	Yes	Yes	Yes	Yes
Sodium Acetate	Yes	Yes	Yes	Yes	Yes	Yes	Yes
Sodium Bicarbonate	Yes	Yes	Yes	Yes	Yes	Yes	Yes
Sodium Bisulfate	Yes	Yes	Yes	Yes	Yes	Yes	Yes
Sodium Chloride	Yes	Yes	Yes	Yes	Yes	Yes	Yes
Sodium Nitrate	Yes	Yes	Yes	Yes	Yes	Yes	Yes
Zinc Sulfate	Yes	Yes	Yes	Yes	Yes	Yes	Yes

3 Properties

CHEMICAL	GAR-MAX®	GAR-FIL®	HSG	MLG	HPM/HPMB®	HPF®/GGB MEGALIFE™ XT	Multifil
Alcohols							
Acetol	Yes	Yes	Yes	Yes	Yes	Yes	Yes
Allyl	No	No	No	No	No	No	No
Amyl	Yes	Yes	Yes	Yes	Yes	Yes	Yes
Butyl	No	No	No	No	No	No	No
Ethyl	Yes	Yes	Yes	Yes	Yes	Yes	Yes
Iso Butyl	Yes	Yes	Yes	Yes	Yes	Yes	Yes
Iso Propyl	Yes	Yes	Yes	Yes	Yes	Yes	Yes
Methyl	Yes	Yes	Yes	Yes	Yes	Yes	Yes
Propyl	Yes	Yes	Yes	Yes	Yes	Yes	Yes
Solvents							
Acetone	Yes	Yes	Yes	Yes	Yes	Yes	Yes
Benzene	No	No	No	No	No	No	No
Carbon Tetrachloride	Yes	Yes	Yes	Yes	Yes	Yes	Yes
Methylene Chloride	No	No	No	No	No	No	No
Methyl Ethyl Ketone	Yes	Yes	Yes	Yes	Yes	Yes	Yes
Naphtha	Yes	Yes	Yes	Yes	Yes	Yes	Yes
Toluol	Yes	Yes	Yes	Yes	Yes	Yes	Yes
Trichlorethane	No	Yes	No	No	No	Yes	Yes
Oils							
Cottonseed	Yes	Yes	Yes	Yes	Yes	Yes	Yes
Crude Oil	Yes	Yes	Yes	Yes	Yes	Yes	Yes
Hydraulic Fluids	Yes	Yes	Yes	Yes	Yes	Yes	Yes
Linseed Oil	Yes	Yes	Yes	Yes	Yes	Yes	Yes
Motor Oil	Yes	Yes	Yes	Yes	Yes	Yes	Yes
Transmission Fluids	Yes	Yes	Yes	Yes	Yes	Yes	Yes

CHEMICAL	GAR-MAX®	GAR-FIL®	HSG	MLG	HPM/HPMB®	HPF®/GGB MEGALIFE™ XT	Multifil
Fuels							
Diesel	Yes	Yes	Yes	Yes	Yes	Yes	Yes
Gasoline	Yes	Yes	Yes	Yes	Yes	Yes	Yes
Jet Fuel	Yes	Yes	Yes	Yes	Yes	Yes	Yes
Kerosene	Yes	Yes	Yes	Yes	Yes	Yes	Yes
Gases	Yes	Yes	Yes	Yes	Yes	Yes	Yes
Acetylene Bromine	No	No	No	No	No	No	No
Butane	Yes	Yes	Yes	Yes	Yes	Yes	Yes
Carbon Dioxide	Yes	Yes	Yes	Yes	Yes	Yes	Yes
Chlorine	No	Yes	No	No	No	Yes	Yes
Ethers	Yes	Yes	Yes	Yes	Yes	Yes	Yes
Fluorine	No	No	No	No	No	No	No
Hydrogen	Yes	Yes	Yes	Yes	Yes	Yes	Yes
Natural Gas	Yes	Yes	Yes	Yes	Yes	Yes	Yes
Nitrogen	Yes	Yes	Yes	Yes	Yes	Yes	Yes
Ozone	Yes	Yes	Yes	Yes	Yes	Yes	Yes
Propane	Yes	Yes	Yes	Yes	Yes	Yes	Yes
Sulfur Dioxide	Yes	Yes	Yes	Yes	Yes	Yes	Yes
Miscellaneous							
Anhydrous Ammonia	No	No	No	No	No	No	No
Detergents	Yes	Yes	es	Yes	Yes	Yes	Yes
Ethylene Glycol	Yes	Yes	Yes	Yes	Yes	Yes	Yes
Formaldehyde	Yes	Yes	Yes	Yes	Yes	Yes	Yes
Freon	Yes	Yes	Yes	Yes	Yes	Yes	Yes
Hydrogen Peroxide	No	No	No	No	No	No	No
Lime	Yes	Yes	Yes	Yes	Yes	Yes	Yes
Water	Yes	Yes	Yes	Yes	Yes	Yes	Yes
Sea water	Yes	Yes	Yes	Yes	Yes	Yes	Yes

Table 4: Chemical Resistance



4 Data for Designers

4.1 WEAR RATE

In the high load applications anticipated for fiber reinforced composite bearings, radial displacement will result from a combination of many variables. These include adhesive wear, abrasion, deformation due to misalignment of the shaft, high interface temperatures, ingress of dirt, fluid contamination and mating surface conditions. With design pressures of less than 103 N/mm² [15,000 psi], millions of cycles can be achieved with GAR-MAX[®], HSG, GAR-FIL[®], HPMB[®], HPM and HPF[®] bearings.

Figure 3 shows the rate of wear measured in continuous cycle testing for GAR-MAX[®], HPMB[®] and GAR-FIL[®] bearings.

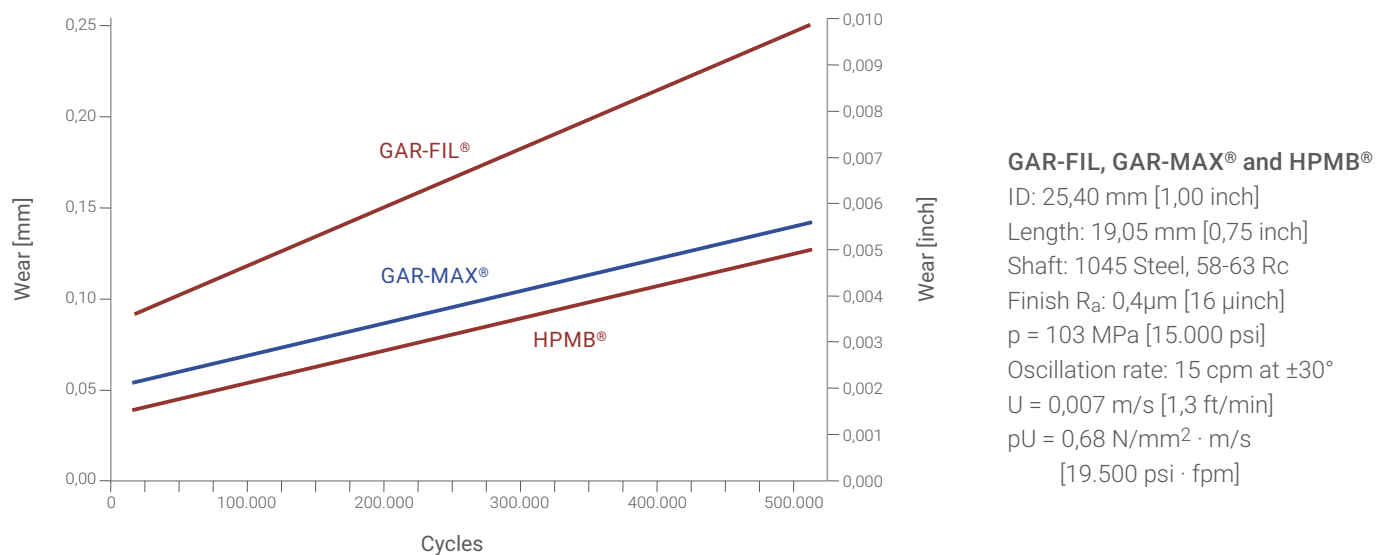

Fig. 3: Wear rate for GAR-FIL, GAR-MAX and HPMB

4.2 FRICTIONAL PROPERTIES

The prime factors affecting the friction of fiber reinforced composite bearings are pressure, speed, temperature and mating surface conditions. Generally, the pressure is the most influential.

Fig. 5 shows how friction changes at various pressures. This information can be used to estimate the torque required to initiate motion in GGB fiber reinforced composite bearings:

$$(4.2.1) \quad \text{Torque} = \frac{\mu \cdot F \cdot D_i}{2000} \quad [\text{N} \cdot \text{m}]$$

$$(4.2.2) \quad \text{Torque} = \frac{\mu \cdot F \cdot D_i}{2} \quad [\text{lbs} \cdot \text{in}]$$

WHERE	
μ	Coefficient of friction
F	Applied load, [Newtons] or [pounds]
D_i	Bearing nominal ID, [mm] or [inches]

With frequent starts and stops, the static coefficient of friction is approximately equal to or slightly less than the dynamic coefficient of friction as measured in laboratory testing. After progressively longer periods of sitting idle or dwell under load (e.g., of hours or days), the static coefficient of friction of the first movement has been measured to be up to 200% higher, particularly before bedding-in. This phenomenon must be considered when designing long dwell period applications. Extremely low torque applications should be monitored or specifically tested for friction when prime mover torque requirements must be determined.

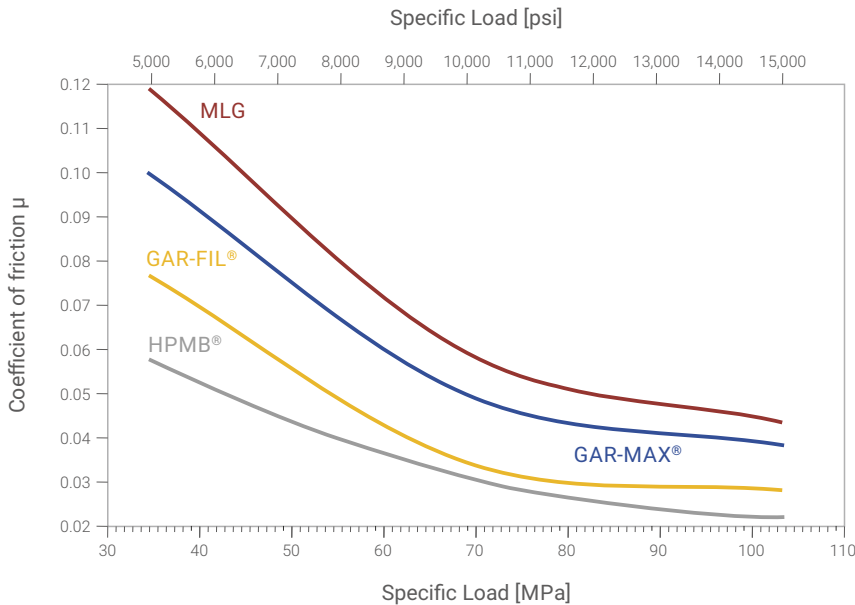

Test Conditions:

ID: 25.40 mm [1.00 inch]
 OD: 31.75 mm [1.25 inch]
 Length: 19.05 mm [0.75 inch]
 Shaft: 1045 Steel, 58-63 Rc
 Finish R_a : 0.13 μm [5 μinch]
 Oscillation rate: 15 cpm at $\pm 30^\circ$
 $U = 0.007 \text{ m/s}$ [1.3 ft/min]
 Break-in for 24 hours at 103 MPa [15,000 psi] prior to measuring friction

Fig.4: Coefficient of friction vs specific load

4 Data for Designers

4.3 OPERATING TEMPERATURE

Operating temperature is an important consideration when specifying bearing products since temperature will have a direct affect on bearing load capacity and wear resistance. GGB fiber reinforced composite bearings consist of a rugged outer shell of fiber reinforced composite fiberglass encapsulated in high temperature epoxy.

This combination of materials enables GGB fiber reinforced composite bearings to operate at higher temperatures than most other conventional plain bearings as indicated in Table 3.

At elevated temperatures GGB fiber reinforced composite bearings have reduced load carrying capabilities due to the softening of the self-lubricating surfaces. However, GAR-MAX[®], MLG, HPMB[®] and HPM are not influenced by temperature to the same degree as GAR-FIL[®] and HPF[®]. GAR-FIL[®] bearings have been used in low temperature (cryogenic) applications.

4.4 LOAD CAPACITY

The maximum unit load which can be supported by fiber reinforced composite bearings will depend upon the type of load. It will be highest under steady loads, whereas, dynamic loads or oscillating motion, which produce fatigue stresses in the bearing, will result in a reduction of load capacity.

The maximum unit loads specified in Table 2 assume good alignment between the bearing and mating surface and running clearances listed in the standard product tables on pages 39 through 48.

The maximum static and dynamic loads given in Table 2 are based on bearings having a wall thickness of 2.5 mm [0.100 inch] or greater. Thin-walled bearings, those with a wall thickness between 1.5 mm [0.060 inch] and 2.5 mm [0.100 inch] have a reduced load capacity because of the reduced number of fiber reinforced composite fiberglass crossovers that constitute the backing material. Wall thicknesses greater than 6.35 mm [0.250 inch] do not increase load capacity.

Many applications for GAR-MAX[®], HBMB[®], and HSG bearings involve applied loads plus the presence of shock and impulse loading along with additional loads due to structural bending. As an example, hydraulic cylinder pivots or clevis joints used in front end loaders, graders, and other types of off-highway vehicles require the consideration of misalignment and G-impact force. Experience gained in the application of GAR-MAX[®] and HSG bearings on this type of equipment has led us to recommend the maximum specific load (pressures) shown in Table 5. Greater specific loads have shown surface distress in operation since the cumulative influence of misalignment and shock will increase the actual specific load.

The bearing length can also influence the distribution of load along the length of the bearing. A bearing that is heavily loaded and having a relatively long length will, due to shaft deflection, have disproportionately high unit loading at each end. For this reason, we do not recommend length-to-diameter ratios that are greater than 2.0. Conversely, very short bearings, those with length-to-diameter ratios less than 0.25 are not recommended because of potential bearing retention problems.

APPLICATION	DSIGN SPECIFIC LOAD*		IMPACT [G]
	N/mm ²	psi	
Dozer Yoke	34	5,000	3
Excavators	34	5,000	3
Back Hoes	34	5,000	3
Loader Linkages	34	5,000	3
Rollers	48	7,000	2
Bogie Wheel Pivots	48	7,000	2
Track Frame Pivots	48	7,000	2
Steer Cylinders	69	10,000	1
Control Linkage	69	10,000	1
Dump/Swing Cylinders	69	10,000	1

* Includes hydraulic check valve pressure but does not include impact, misalignment or vehicle driving force

Table 5: Specific application impact loading factors

4.5 SURFACE VELOCITY

GGB's fiber reinforced composite bearings can operate over a wide range of operating velocities as shown in Table 2.

GAR-FIL[®] and HPF[®] bearings can operate without lubrication at speeds up to 2.5 m/s [500 fpm] with a maximum pU value to 0.3 N/mm² x m/s [9,000 psi x fpm]. This performance capability is due to the proprietary filled-PTFE liner.

Since surface velocity influences the amount of heat generated in a plain bearing, additional clearance may be required at higher operating speeds. With GAR-FIL[®] and HPF[®] bearings, when operating over 0.25 m/s [50 fpm], additional clearances are required to accommodate for thermal expansion due to the heat generated.

GAR-MAX[®], HSG, MLG, HPMB[®] and HPM bearings, which have a maximum speed limit of 0.13 m/s [25 fpm], are more suitable for high-load and low-speed applications. Since most GAR-MAX[®], HSG, MLG, HPMB[®] and HPM bearings are designed to operate at less than 0.05 m/s [10 fpm], additional clearances are normally not required.

GGB-MEGALIFE[™] XT thrust bearings are limited to 0.50 m/s [100 fpm].

Multifil bearing tape can operate with speed up to 2.5 m/s [500 fpm].

4.6 pU FACTOR

The pU factor, which is the product of specific load (pressure) times surface velocity, is used as a guide in determining the useful life of plain bearings and is also an indication of heat generated within the bearing contact zone. The maximum pU factors listed in Table 2 are based on high-load and low-speed applications. The calculated unit load p, relative surface velocity U and operating temperature must be used along with the pU factor when selecting a bearing product for a given application. These values are then compared against published maximum recommended values for load, speed, temperature and pU for the bearing product. For an application to be successful, each of the application values must not exceed the published maximum recommended values. To complete the bearing analysis, bearing life should be estimated using the method given in section 5.5

4 Data for Designers

4.7 OPERATING CLEARANCES

Proper running clearance is a critical factor in bearing performance. In low speed oscillating pivot applications, the minimum possible recommended clearance can be as small as 0.013 mm [0.0005 inch] for fiber reinforced composite bearings. The shaft or pin will fit nearly line-to-line during the assembly process. However, since little or no heat is generated during very slow oscillating operation, additional clearance is not required.

For more dynamic applications involving continuous rotation at higher speeds or elevated ambient temperatures, minimum clearances may be as high as 0.005 mm/mm [0.005 inch/inch] of diameter.

GAR-MAX®, HSG, MLG, and HPM bearings cannot be sized or machined on their ID due to the liner composition. However, HPMB®, GAR-FIL® and HPF® bearings can be sized or machined for close tolerance control.

HPMB® bearings can be machined on the inner diameter to the depth up to 1 mm [0.040 inch] on diameter in standard configuration, and to the depth up to 3 mm [0.118 inch] on diameter upon request.

Standard GAR-FIL® and HPF® bearings are supplied with a 0.38 mm [0.015 inch] thick proprietary filled-PTFE tape liner that can be bored at assembly if necessary. GAR-FIL® and HPF® bearings can also be furnished with a thicker liner that allows for a greater depth for boring.

For further information, contact GGB.

4.8 DIMENSIONAL CONSIDERATIONS

Before designing a special GGB fiber reinforced composite bearing, there are several important considerations to keep in mind:

Wall Thickness

Bearings with wall thicknesses less than 2.5 mm [0.100 inch] should be avoided since thin-walled bearings have reduced load capacity, approximately 50% less than our rated load capacity for GGB fiber reinforced composite bearings.

The minimum recommended wall thickness is 1.5 mm [0.060 inch]. Wall thicknesses greater than 6.35 mm [0.250 inch] do not increase load capacity.

Clearance

As noted previously, the minimum running clearance applies only to low speed applications operating at ambient temperatures.

For GAR-FIL® and HPF® bearings operating at surface speeds greater than 0.25 m/s [50 fpm] or at elevated temperatures, additional clearance may be required.

Bearing Length

In designing bearings, the shaft diameter is usually determined by the need for physical stability or stiffness; therefore, only the bearing length must be determined based upon operating pressure and required life.

A short bearing should be limited to a length-to-diameter ratio of 0.25 as a minimum to insure sufficient retention in the housing.

A long bearing is not recommended because of potential shaft deflection and misalignment problems as described in Section 6.0. A long heavily loaded bearing will have disproportionately high specific loading at each end due to shaft deflection. For this reason, we do not recommend length-to-diameter ratios greater than 2.0.

4.9 SHAFT MATERIAL AND SURFACE FINISH

Being part of the complete assembly, an appropriate design of the shaft is of the most utmost importance to obtaining the correct operating performance of the bearing. Most steel alloys are acceptable as shaft materials. Hardened steel shafts offer better performance in high load applications or in the presence of abrasive contaminants by providing greater protection for the mating surface.

When bearing operating pressures exceed a value of about 14 N/mm² [2,000 psi], minimum shaft hardness should be at least Brinell 480 HB [Rockwell C50]. Fully hardened shafts are usually not necessary.

GGB fiber reinforced composite bearings offer good embeddability in the presence of contaminants; however, we strongly recommend the use of seals. Hardened stainless steel or hard chrome plating is recommended when corrosion resistance is required.

Equally important as material selection is shaft surface finish. A surface finish between 0.15 to 0.40 µm [6 to 16 µinches] will insure the most effective bearing performance by assuring maximum bearing wear resistance and lowest coefficient of friction. Rougher surface finishes can be used but there will be a reduction in bearing life. This is due to the rough shaft abrading the relatively soft polymer liner of the bearings.

We recommend that the ends of the shaft have chamfers or rounded edges to facilitate assembly and minimize the chance of scoring the bearing.

4.10 HOUSING MATERIAL

The running clearances given in section 8 for standard GGB fiber reinforced composite bearings are based upon installation in rigid steel or cast iron housings at normal ambient temperature. If the housing is made from non-ferrous alloys, such as aluminum, and will be subjected to elevated operating temperatures, there will be a potential for reduced bearing retention due to the thermal expansion of the housing. In applications where non-ferrous alloy housings are to be used at elevated temperatures, the interference between the bearing and housing bore may have to be increased to assure adequate retention of the bearing in the housing. To prevent shaft interference at assembly, the shaft diameter must be equally reduced to compensate for the additional interference it.

For further information contact GGB.

4.11 LUBRICATION

GGB fiber reinforced composite bearings are recommended to be used dry. However, grease can be used to protect and/or to purge the bearing zone of corrosion or contaminants. In applications where high cyclic vibrations are present, hydrostatic erosion of liner fibers by the grease may occur over long periods of time. This should be monitored to assure liner integrity over the operating life of the equipment.

GAR-FIL[®] and HPF[®] bearings can be used when submerged in oil or other lubricating liquids. Liquidous lubricants will reduce the coefficient of friction and bearing wear. However, the lubricant must be constantly maintained and kept free of abrasive contaminants. Grease is not recommended for GAR-FIL[®] and HPF[®] bearings.

HPMB[®], HPM and HPF[®] bearings are specifically designed for hydropower applications where they can be used both dry and submerged in water. We recommend that hardened stainless steel shafting, such as 440 stainless steel, be used to minimize the chance of shaft corrosion.

GGB- MEGALIFE™ XT washers and sliding plates are typically used dry but can also be used in greased applications.

Multifil bearing tape can be used dry or with lubricants.

Liquid lubricants and greases attract contaminating particles that may migrate into the bearing. To minimize bearing contamination, the use of seals or wipers is highly recommended.

4 Data for Designers

4.12 MULTIFIL BEARING TAPE DESIGN FEATURES

Multifil tape is a superior sliding bearing product developed specifically for machine tool ways, gibs, and other sliding applications. This unique product is a blend of virgin PTFE and a combination of fillers which vastly improve the bearing properties of the base resin.

This bearing tape is widely used by machine tool rebuilders and in-plant personnel to restore existing equipment to like new precision, as well as by many leading machine tool manufacturers. The tape is easy to apply to any clean rigid substrate, inexpensive and provides remarkable performance.

As a sliding bearing product, Multifil tape is unequalled for providing high compressive strength and load carrying capabilities, low friction, precise positioning accuracy and minimal wear – with or without lubrication.

In addition to its rapid, easy installation and economy, the use of Multifil tape eliminates stick-slip, chattering, scuffing, galling due to lubricant breakdown, scoring, uneven wear and override. It reduces or eliminates the need for lubrication, assures improved positioning accuracy and provides almost indefinite service life in most machine tool applications.

Typical applications include milling machines, planers, grinders, vertical boring machines and many more. This tape is particularly recommended for numerically-controlled machines where positioning accuracy and reproducibility are especially critical.

Multifil bearing tape is the ideal replacement for ways of hardened steel, bronze and other metals, hydrostatic supports systems, ball or roller bearings and all other types of bearing tape.

Design Features

Low Friction

Multifil tape provides smooth motion without stick-slip due to its similar values for static and dynamic friction. Tests of machine tools at pressures below 345 kN/m² [50 psi] have shown that filled PTFE can provide a coefficient of friction as low as 0.07 when operated dry. These tests also show that with lubrication, even lower frictional values down to 0.05 can be achieved without causing table override or any loss of positioning accuracy. Increased surface pressures will further improve these values.

Wear

Without lubrication, Multifil bearing tape has the remarkably low wear rate of less than 0.127 mm/1,000 hrs. [0.005 in./1,000 hrs.] at pU values up to 0.35 N/mm² x m/s [10,000 psi x fpm]. The low pU's experienced in machine tool service cause very little wear. In lubricated service, actual field tests have proved that wear of Multifil tape is negligible over extended periods of operation.

Compressive Strength

The excellent compressive strength of Multifil - only 1% deformation at 7,000 kN/m² [1,000 psi] – provides high load carrying capabilities. Multifil tape can operate at pU's in excess of 0.35 N/mm² x m/s [10,000 psi x fpm] particularly with lubrication. For optimum performance, pU levels below 0.18 N/mm² x m/s [5,000 psi x fpm] and adequate lubrication are normally recommended. At surface velocities of less than 0.005 m/s [1 fpm] or near static conditions, the rated allowable pressure is 69 N/mm² [10,000 psi] when the tape is bonded. Multifil's other outstanding physical properties are given in the table on page 11.

Available Sizes

To meet the great majority of machine tool applications, Multifil bearing tape is available in standard thicknesses of 0.38 mm [0.015"], 0.76 mm [0.030"], 1.14 mm [0.045"], 1.52 mm [0.060"], 2.29 mm [0.090"], and 3.18 mm [0.125"], in standard widths of 305 mm [12"] and 610 mm [24"], and lengths up to 30 m [100"].

Rapid, Easy Installation

Multifil tape can be applied to any properly prepared machine surface using a good quality industrial epoxy adhesive. Adhesive bonding eliminates the need for holes and fastening devices, improves the fatigue life of the surface material and permits the use of lighter gage materials for maximum economy.

Surface Preparation

The surface to which the tape will be applied must be clean. To remove oxidation and other contamination, various cleaning methods can be used, including sanding, grinding, sandblasting or acid etching. Milled surfaces should be grit blasted prior to bonding. Ra surface finish 0.8 - 3.2 μm [32 - 125 μinch] is recommended for proper bonding. The surface should then be thoroughly degreased with a suitable oil-free solvent in a well-ventilated area and wiped clean with a dry, lint-free cloth. An air gun can be used to accelerate drying of the clean surface.

Preparing the Tape

The tape can be easily cut to the desired length and width with a utility knife. The tape is chemically etched on one side to assure optimum bonding. To positively identify the bondable side, simply apply water to both sides. The water will bead up on the bearing side, while the bonding side will appear wet. Care should be taken to keep the bonding side of the tape clean since any foreign material, including moisture, finger marks, grease or oil will prevent a perfect bond.

Preparing the Adhesive

A good two-part, room-temperature cure epoxy adhesive should be used to provide high shear strength. The adhesive should be prepared according to the manufacturer's instructions prior to application. Adequate eye and hand protection are recommended when working with any epoxy.

If the bonded bearing tape will be subsequently subjected to chlorinated oils and cutting fluids, then a chlorine resistant epoxy cured to suit manufacturer's instructions should be used.

Applying the Adhesive and Tape

A thin, even coat of adhesive should be applied to both the tape and the machine surface. The total glue line should be approximately 5-6 mils after assembly. Edge locators (Figure 5) should be used to prevent the tape from sliding out of position. C-clamps or other devices that cause uneven pressure should not be used. After carefully positioning, the tape should be covered with a rigid flat pressure plate, with additional weights evenly distributed to provide loading of 14-35 kN/m^2 [2-5 psi]. The use of grease-proof release paper to prevent cleanup problems is also recommended.

Final Sizing

After the adhesive is cured (usually overnight), the bearing tape can be easily machined, ground or hand-scraped to the dimensional tolerances required by the specific application. For grinding large areas, a coolant – preferably a water soluble, oil emulsion grinding fluid, diluted 100:1 – should be used. Lubrication grooves can also be machined into the tape. The depth of these grooves should be less than the thickness of the tape to prevent peeling and avoid problems in the event of repair or replacement. The final machining operation compensates for variations in the tolerance of the machine surface and the thickness of the tape and bond line.

Mating Surfaces

For optimum performance, the surface finish of the mating material should not exceed 20 AA. Steel is generally used. If cast iron is used, a finer finish (10 AA) is recommended due to the open surface texture of this material. While mating surface hardness is not a requirement except in abrasive atmospheres, good surface finish is important. A surface that is too rough will accelerate wear and cause excessive friction.

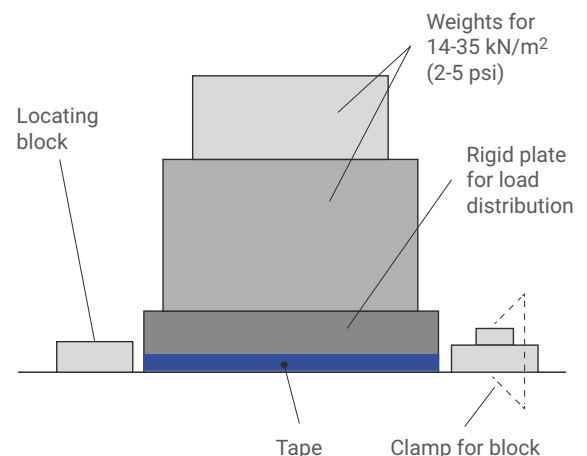

Fig. 5: Application of Multifil bearing tape

5 Performance

The following section describes how to estimate bearing life for GGB fiber reinforced composite bearings. This method involves calculation of the pU factor which is then further modified by application factors for unit loading, bearing length, operating temperature, mating surface and bearing diameter. If you need additional assistance in estimating bearing life, feel free to contact GGB.

5.1 DESIGN FACTORS

The main parameters when determining the size or estimating the service life for a GGB fiber reinforced composite bearings are:

- Specific load limit, p_{lim}
- pU factor
- Length-to-diameter ratio
- Mating surface finish
- Mating surface material
- Temperature
- Other environmental factors, e.g., housing design, dirt, lubrication

5.2 SPECIFIC LOAD p

The formula for calculating the specific load, p, for bearings is:

$$(5.2.1) \quad p = \frac{F}{D_i \cdot B} \quad \text{[N/mm}^2\text{] or [psi]}$$

WHERE	
p	Specific load, [N/mm ²] or [psi]
F	Applied load, [Newtons] or [pounds]
D _i	Bearing nominal ID, [mm] or [inches]
B	Bearing length, [mm] or [inches]

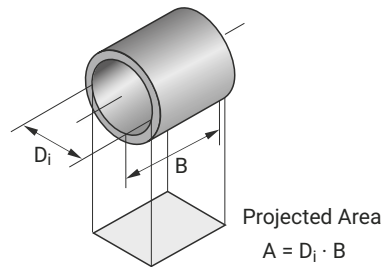

Fig. 6: Projected area for bearing

5.3 SLIDING SPEED U

The formula for calculating the sliding speed is:

$$(5.3.1) \quad U = \frac{D_j \cdot \pi \cdot N}{60 \cdot 10^3} \quad [\text{m/s}]$$

$$(5.3.2) \quad U = \frac{D_j \cdot \pi \cdot N}{12} \quad [\text{fpm}]$$

WHERE

U Sliding speed, [m/s] or [fpm]

N Rotational speed, [1/min]

For oscillating applications

$$(5.3.3) \quad N = \frac{4\varphi \cdot N_{osc}}{360} \quad [1/\text{min}]$$

WHERE

N_{osc} Oscillating movement frequency, [1/min]

φ Angular displacement, [°]

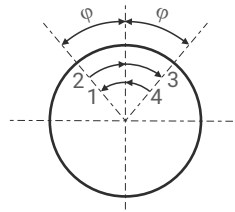

Figure 7: Oscillating cycle φ

5.4 pU FACTOR

The useful life of a GGB fiber reinforced composite bearing is governed by the pU factor, the product of the specific load p and the sliding speed U, as defined in 5.2 and 5.3 respectively.

The formula for calculating pU is:

$$(5.4.1) \quad pU = p \cdot U \quad [\text{N/mm}^2 \cdot \text{m/s}] \text{ or } [\text{psi} \cdot \text{fpm}]$$

5 Performance

5.5 ESTIMATING BEARING LIFE

Cyclic Bearing Life L_Q

The cyclic bearing life of a GGB fiber reinforced composite bearing is estimated by using the following formula:

$$(5.5.1) \quad L_Q = \frac{Q_{GM}}{\rho U} \cdot a_E \cdot a_T \cdot a_M \cdot a_S \cdot a_B \quad [\text{cycles}]$$

for GAR-MAX®, HPMB® and HSG

$$(5.5.2) \quad L_Q = \frac{Q_{MLG}}{\rho U} \cdot a_E \cdot a_T \cdot a_M \cdot a_S \cdot a_B \quad [\text{cycles}]$$

for MLG

$$(5.5.3) \quad L_Q = \frac{Q_{GF}}{\rho U} \cdot a_E \cdot a_T \cdot a_M \cdot a_S \cdot a_B \quad [\text{cycles}]$$

for GAR-FIL®

WHERE	
L_Q	Estimated bearing life, [cycles]
Q_{GM}	GAR-MAX® HPMB® and HSG cyclic life factor, see Table 6
Q_{MLG}	MLG cyclic life factor, see Table 6
Q_{GF}	GAR-FIL® cyclic life factor, see Table 6
ρU	ρU factor, $\rho \times U$, [N/mm ² x m/s] or [psi x fpm]
a_E	High load factor
a_T	Temperature factor
a_M	Mating surface factor
a_S	Surface finish factor
a_B	Bearing size factor

PRODUCT	FACTOR	CYCLIC LIFE FACTORS	
GAR-MAX®	Q_{GM}	$3.8 \cdot 10^6 \text{ N/mm}^2 \cdot \text{m/s}$	$11 \cdot 10^{10} \text{ psi} \cdot \text{fpm}$
HSG	Q_{GM}	$3.8 \cdot 10^6 \text{ N/mm}^2 \cdot \text{m/s}$	$11 \cdot 10^{10} \text{ psi} \cdot \text{fpm}$
HPMB®	Q_{GM}	$3.8 \cdot 10^6 \text{ N/mm}^2 \cdot \text{m/s}$	$11 \cdot 10^{10} \text{ psi} \cdot \text{fpm}$
MLG	Q_{MLG}	$1.4 \cdot 10^6 \text{ N/mm}^2 \cdot \text{m/s}$	$4 \cdot 10^{10} \text{ psi} \cdot \text{fpm}$
GAR-FIL®	Q_{GF}	$2.4 \cdot 10^6 \text{ N/mm}^2 \cdot \text{m/s}$	$7 \cdot 10^{10} \text{ psi} \cdot \text{fpm}$

Table 6: Cyclic Life Factors

High Load Factor a_E

The high load factor considers both the effect of the specific load and the bearing's B/D_i (length-to-diameter) ratio. Table 7 shows the specific load limit, p_{lim} for various operating conditions. Fig. 7 shows a graph of the length factor, a_{B/D_i} , versus B/D_i . Once the values for p_{lim} and a_{B/D_i} are selected, the high load factor, a_E , can be calculated as shown. If the calculated a_E value is negative, then the designer must consider a larger bearing in order to reduce the specific load p .

$$(5.5.4) \quad a_E = \left(\frac{p_{lim} - p}{p_{lim}} \right)^{a_{B/D_i}} \quad [-]$$

WHERE	
p_{lim}	Specific load limit, see table 7, [N/mm ²] or [psi]
p	Specific load, [N/mm ²] or [psi]
a_{B/D_i}	B/D_i factor taken from Fig. 9

TYPE OF LOADING	UNITS	SPECIFIC LOAD LIMIT p_{lim}	
		GAR-MAX®, HSG, HPMB®, MLG	GAR-FIL®
Steady unidirectional loads relative to the bearing surface with rotation in one direction only	MPa	138	138
	psi	20,000	20,000
Steady unidirectional loads with oscillating motion	MPa	138	138
	psi	20,000	20,000
Dynamic loads, alternating or fluctuating, with rotating or oscillating motion	MPa	103	103
	psi	15,000	15,000
Rotating load relative to bearing surface, e.g., fully rotational bearing on stationary shaft	MPa	55 (U < 0.025 m/s)	14 (U < 0.125 m/s)
	psi	8,000 (< 5 fpm)	2,000 (< 25 fpm)

Table 7: Specific load limit p_{lim}

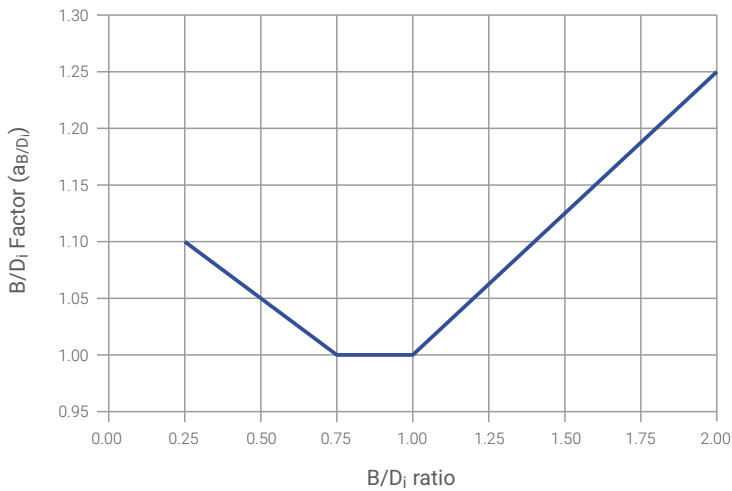

Fig. 8: B/D_i factor (a_{B/D_i})

Type of Load

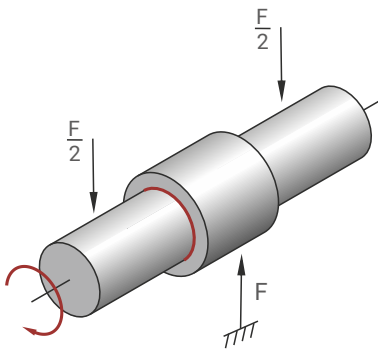

Fig. 9: Steady load, bush stationary, shaft rotating

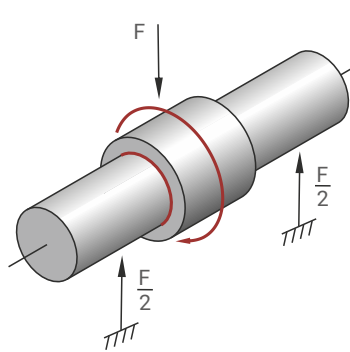

Fig. 10: Rotating load, shaft stationary, bush rotating

5 Performance

Temperature Factor a_T

The effect of environmental temperature on the bearing life is given in Figure 11. Elevated temperatures tend to soften the non-metallic bearing surface resulting in reduced wear resistance and load capacity. Since the bearing surface of GAR-FIL® consists of a proprietary filled PTFE material, bearing life will be influenced by temperature to a greater degree than GAR-MAX®, HSG, HPMB® and MLG. When the operating temperature approaches the top limit of 205 °C [400 °F] for GAR-FIL® or 163 °C [325 °F] for GAR-MAX®, HSG, HPMB® and MLG, please contact GGB.

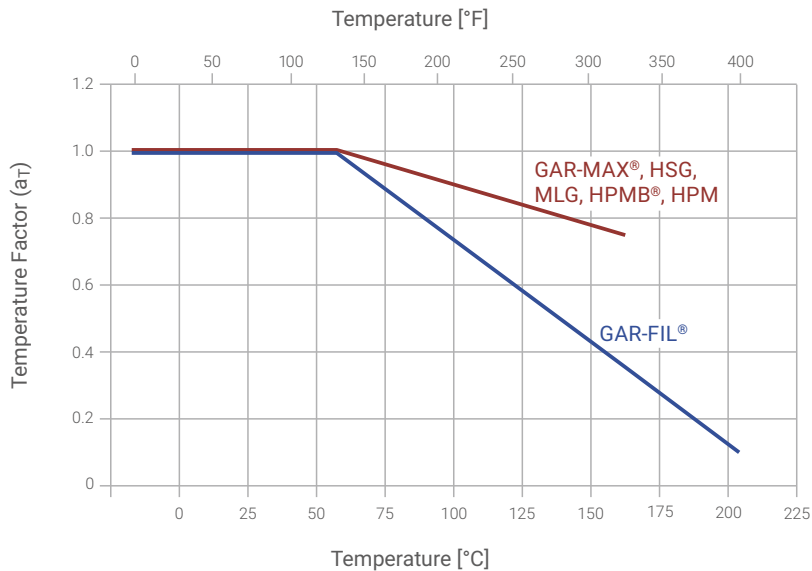

Fig. 11: Temperature factor a_T

Mating Material Factor a_M

The effect of shaft material on self-lubricating bearing life is reflected in Table 8 which lists the mating surface material factors a_M for many commonly used shaft materials and shaft finishes. When plated shafting is to be used, designers should specify that the plating possesses adequate strength and adhesion.

MATERIAL	MATING SURFACE FACTOR a_M
STEELS	
Case-hardened Steel	1
Mild Steel	1
Nitrided Steel	1
Hardened Stainless Steel	1.2
NON-FERROUS METALS	
Bronze & Copper Based Alloys	0.1 - 0.4
Hard Anodized Aluminium, 0.025 mm (0.001 inch) thick	1.5
PLATED STEEL, 0.013 MM (0.0005 INCH) MINIMUM PLATING THICKNESS	
Hard Chrome (polished after plating)	1.2
Tin Nickel	1.2
Tungsten Carbide Flame Plated	1.5
Zinc (Galvanized)	0.2

Table 8: Mating surface factor a_M

Mating Surface Factor a_s

Shaft surface finish is a very important consideration when estimating bearing life. Figure 12 shows a relationship of the mating surface factor a_s with respect to surface finish in micrometers [micrometers]. To maximize bearing life, a R_a surface finish of 0.15 to 0.40 μm [6 to 16 μinch] is recommended. Rougher surface finishes will result in reduced bearing life because they will tend to rake through the soft polymer liners and accelerate wear. On the other hand, very fine finishes do not permit the adequate transfer of the self-lubricating material onto the shaft surface and will also tend to reduce bearing life in dry applications. If rougher finishes are to be considered, testing should be conducted based on dynamics and operating pressures for the application.

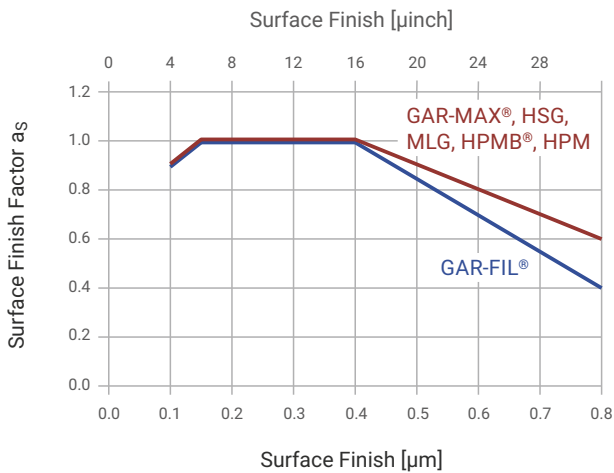

Fig. 12: Mating Surface Factor a_s

Bearing Size Factor a_B

As the bearing size increases there is a relatively smaller angular contact area after initial bedding-in occurs. This reduction in contact area has the effect of increasing the actual unit loading and consequently will result in reducing bearing life. The bearing size factor a_B versus shaft diameter is plotted in Figure 13.

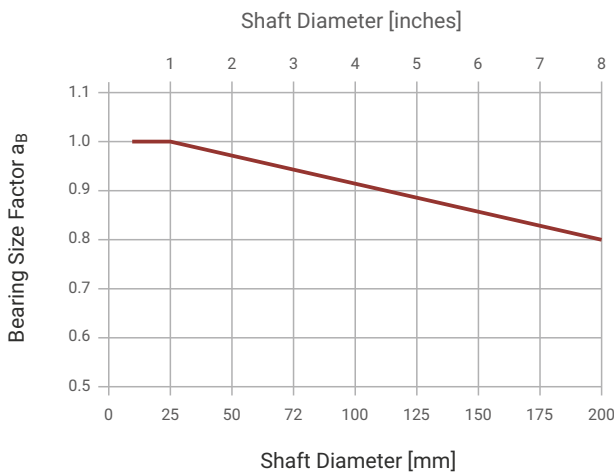

Fig. 13: Bearing Size Factor a_B

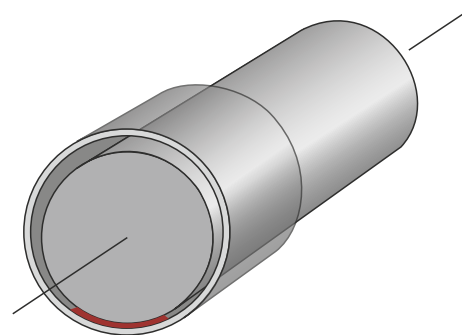

Fig. 14: Contact area between bearing and shaft

5 Performance

5.6 WORKED EXAMPLES

GAR-MAX®



Given:			
Load Details	Steady Load Shaft Oscillating	Inside Diameter D_i Length B	2.25 inch 2.00 inch $\frac{B}{D_i} = \frac{2.00}{2.25} = 0.89$
Shaft Environment	Hardened Steel, $R_a = 20 \mu\text{inch}$ Ambient Temperature = 72 °F	Bearing Load F Frequency N_{OSC} Amplitudes ϕ	60,000 pounds 15 cycles/min 20°

Calculation Constants and Application Factors		
Specific Load Limit p_{lim}	20,000 psi	(Table 7, Page 35)
B/ D_i Factor a_{B/D_i}	1.0	(Figure 9, Page 35)
Temperature a_T	1.0	(Figure 12, Page 36)
Material Application Factor a_M	1.0	(Table 8, Page 36)
Mating Surface Factor a_s	0.9	(Figure 13, Page 37)
Bearing Size Factor a_B	0.96	(Figure 14, Page 37)
Cyclic Life Factor Q_{GM}	$11 \cdot 10^{10}$ psi · fpm	(Table 6, Page 34)

Calculation	Ref	Value
Specific Load p [N/mm ²] or [psi]	(5.2.1) Page 32	$p = \frac{F}{D_i \cdot B} = \frac{60,000}{2.25 \cdot 2.00} = 13,333 \text{ psi}$
Sliding Speed U [m/s] or [fpm]	(5.3.1) Page 33	$U = \frac{D_i \cdot \pi \cdot N}{12} = \frac{2.25 \cdot 3.14 \cdot 3.333}{12} = 1.96 \text{ fpm}$ $N = \frac{4 \cdot \phi \cdot N_{OSC}}{360} = 3.333 \text{ rpm}$
pU Factor [N/mm ² · m/s] or [psi · fpm]	(5.4.1) Page 33	$pU = p \cdot U = 13,333 \cdot 1.96 = 26,133 \text{ psi} \cdot \text{fpm}$
High Load Factor a_E	(5.5.4) Page 34	$a_E = \left(\frac{p_{lim} - p}{p_{lim}} \right)^{a_{B/D_i}} = \left(\frac{20,000 - 13,333}{20,000} \right)^{1.25} = 0.333$
Life L_Q [cycles]	(5.5.1) Page 34	$L_Q = \frac{Q_{GM}}{pU} \cdot a_E \cdot a_T \cdot a_M \cdot a_s \cdot a_B = \frac{11 \cdot 10^{10}}{26,133} \cdot 0.333 \cdot 1.0 \cdot 1.0 \cdot 0.9 \cdot 0.96$ $= 1.2 \cdot 10^6 \text{ cycles}$

GAR-FIL®



Given:				
Load Details	Steady Load Shaft Oscillating	Inside Diameter D_i	40 mm	$\frac{B}{D_i} = \frac{20}{40} = 0.5$
		Length B	20 mm	
Shaft Environment	Hardened Steel, $R_a = 0.2 \mu\text{m}$ Ambient Temperature = 75 °C	Bearing Load F	50.000 Newtons	
		Frequency N_{OSC}	10 cycles/min	
		Amplitudes φ	30°	

Calculation Constants and Application Factors		
Specific Load Limit p_{lim}	138 N/mm ²	(Table 7, Page 35)
B/ D_i Factor a_{B/D_i}	1.05	(Figure 9, Page 35)
Temperature a_T	0.9	(Figure 12, Page 36)
Material Application Factor a_M	1.2	(Table 8, Page 36)
Mating Surface Factor a_S	1.0	(Figure 13, Page 37)
Bearing Size Factor a_B	0.98	(Figure 14, Page 37)
Cyclic Life Factor Q_{GF}	$2.4 \cdot 10^6 \text{ N/mm}^2 \cdot \text{m/s}$	(Table 6, Page 34)

Calculation	Ref	Value
Specific Load p [N/mm ²] or [psi]	(5.2.1) Page 32	$p = \frac{F}{D_i \cdot B} = \frac{50.000}{40 \cdot 20} = 62.5 \text{ N/mm}^2$
Sliding Speed U [m/s] or [fpm]	(5.3.1) Page 33	$U = \frac{D_i \cdot \pi \cdot N}{60 \cdot 10^3} = \frac{40 \cdot 3.14 \cdot 3.333}{60 \cdot 10^3} = 0.007 \text{ m/s}$ $N = \frac{4 \cdot \varphi \cdot N_{OSC}}{360} = 3.333 \text{ m/s}$
pU Factor [N/mm ² · m/s] or [psi · fpm]	(5.4.1) Page 33	$pU = p \cdot U = 62.5 \cdot 0.007 = 0.438 \text{ N/mm}^2 \cdot \text{m/s}$
High Load Factor a_E	(5.5.4) Page 34	$a_E = \left(\frac{p_{lim} - p}{p_{lim}} \right)^{a_{B/D_i}} = \left(\frac{138 - 62.5}{138} \right)^{1.05} = 0.531$
Life L_Q [cycles]	(5.5.1) Page 34	$L_Q = \frac{Q_{GF}}{pU} \cdot a_E \cdot a_T \cdot a_M \cdot a_S \cdot a_B = \frac{2.4 \cdot 10^6}{0.438} \cdot 0.531 \cdot 0.9 \cdot 1.2 \cdot 1.0 \cdot 0.98$ $= 3.1 \cdot 10^6 \text{ cycles}$

5 Performance

5.6 WORKED EXAMPLES

HPMB®

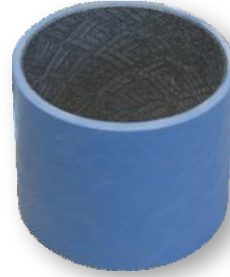

Given:			
Load Details	Steady Load Shaft Oscillating	Inside Diameter D_i Length B	150 mm 100 mm $\frac{B}{D_i} = \frac{100}{150} = 0.67$
Shaft Environment	Hardened Steel, $R_a = 0.4 \mu\text{m}$ Ambient Temperature = 22 °C	Bearing Load F Frequency N_{OSC} Amplitudes φ	800 KN 6 cycles/min 15°

Calculation Constants and Application Factors		
Specific Load Limit p_{lim}	103 N/mm ²	(Table 7, Page 35)
B/ D_i Factor a_{B/D_i}	1.02	(Figure 9, Page 35)
Temperature a_T	1.0	(Figure 12, Page 36)
Material Application Factor a_M	1.0	(Table 8, Page 36)
Mating Surface Factor a_S	1.0	(Figure 13, Page 37)
Bearing Size Factor a_B	0.85	(Figure 14, Page 37)
Cyclic Life Factor Q_{GF}	$3.8 \cdot 10^6 \text{ N/mm}^2 \cdot \text{m/s}$	(Table 6, Page 34)

Calculation	Ref	Value
Specific Load p [N/mm ²] or [psi]	(5.2.1) Page 32	$p = \frac{F}{D_i \cdot B} = \frac{800,000}{150 \cdot 100} = 53 \text{ N/mm}^2$
Sliding Speed U [m/s] or [fpm]	(5.3.1) Page 33	$U = \frac{D_i \cdot \pi \cdot N}{60 \cdot 10^3} = \frac{150 \cdot 3.14 \cdot 1}{60 \cdot 10^3} = 0.0078 \text{ m/s}$ $N = \frac{4 \cdot \varphi \cdot N_{OSC}}{360} = 1 \text{ rpm}$
pU Factor [N/mm ² · m/s] or [psi · fpm]	(5.4.1) Page 33	$pU = p \cdot U = 53 \cdot 0.0078 = 0.41 \text{ N/mm}^2 \cdot \text{m/s}$
High Load Factor a_E	(5.5.4) Page 34	$a_E = \left(\frac{p_{lim} - p}{p_{lim}} \right)^{a_{B/D_i}} = \left(\frac{103 - 53}{103} \right)^{1.02} = 0.478$
Life L_Q [cycles]	(5.5.1) Page 34	$L_Q = \frac{Q_{GM}}{pU} \cdot a_E \cdot a_T \cdot a_M \cdot a_S \cdot a_B = \frac{3.8 \cdot 10^6}{0.41} \cdot 0.478 \cdot 1.0 \cdot 1.0 \cdot 1.0 \cdot 0.85$ $= 3.7 \cdot 10^6 \text{ cycles}$

MLG



Given:			
Load Details	Steady Load Shaft Oscillating	Inside Diameter D_i Length B	1.25 inch 2.50 inch $\frac{B}{D_i} = \frac{2.50}{1.25} = 2.0$
Shaft Environment	Hardened Steel, $R_a = 32 \mu\text{inch}$ Ambient Temperature = 120 °F	Bearing Load F Frequency N_{OSC} Amplitudes ϕ	40,000 pounds 20 cycles/min 30°

Calculation Constants and Application Factors		
Specific Load Limit p_{lim}	20,000 psi	(Table 7, Page 35)
B/D_i Factor a_{B/D_i}	1.25	(Figure 9, Page 35)
Temperature a_T	1.0	(Figure 12, Page 36)
Material Application Factor a_M	1.0	(Table 8, Page 36)
Mating Surface Factor a_S	0.6	(Figure 13, Page 37)
Bearing Size Factor a_B	0.99	(Figure 14, Page 37)
Cyclic Life Factor Q_{GM}	$4 \cdot 10^{10}$ psi · fpm	(Table 6, Page 34)

Calculation	Ref	Value
Specific Load p [N/mm ²] or [psi]	(5.2.1) Page 32	$p = \frac{F}{D_i \cdot B} = \frac{40,000}{1.25 \cdot 2.50} = 12,800$ psi
Sliding Speed U [m/s] or [fpm]	(5.3.1) Page 33	$U = \frac{D_i \cdot \pi \cdot N}{12} = \frac{1.25 \cdot 3.14 \cdot 6.667}{12} = 2,182$ fpm $N = \frac{4 \cdot \phi \cdot N_{OSC}}{360} = 6.667$ rpm
pU Factor [N/mm ² · m/s] or [psi · fpm]	(5.4.1) Page 33	$pU = p \cdot U = 12,800 \cdot 2,182 = 27,930$ psi · fpm
High Load Factor a_E	(5.5.4) Page 34	$a_E = \left(\frac{p_{lim} - p}{p_{lim}} \right)^{a_{B/D_i}} = \left(\frac{20,000 - 12,800}{20,000} \right)^{1.25} = 0.279$
Life L_Q [cycles]	(5.5.1) Page 34	$L_Q = \frac{Q_{MLG}}{pU} \cdot a_E \cdot a_T \cdot a_M \cdot a_S \cdot a_B = \frac{4 \cdot 10^{10}}{27,930} \cdot 0.279 \cdot 1.0 \cdot 1.0 \cdot 0.6 \cdot 0.99$ $= 12.3 \cdot 10^5$ cycles

6 Misalignment

Bearings operating with proper shaft alignment are uniformly loaded along their length as shown in Figure 15. In the right side of Figure 16 is a top view of the contact area. Shaft misalignment reduces the contact area and shifts the bearing pressure distribution to one end of the bearing, as illustrated in Figure 16. With substantial misalignment the contact area reduces to a parabolic shape as shown in Figure 17. The concentrated edge pressure due to the excessive misalignment can cause bearing failure. When the edge pressure products stresses that approach or exceed the compressive strength of the material, fracture may occur.

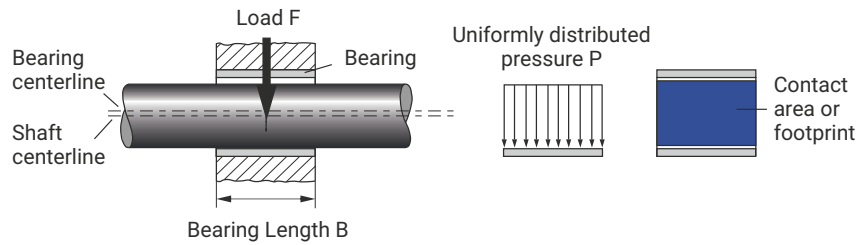

Fig. 15: Properly aligned shaft

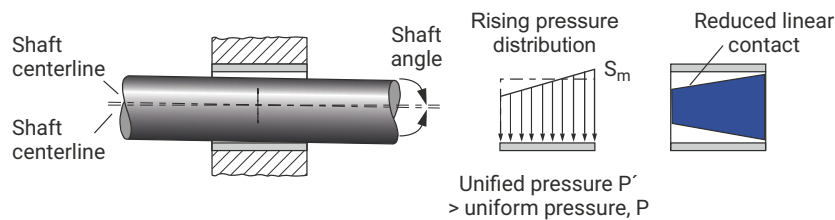

Fig. 16: Slight misalignment

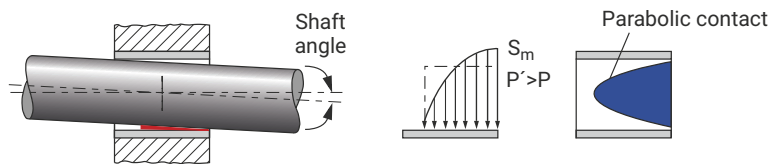

Fig. 17: Substantial misalignment

If it is known from experience that misalignment and/or shaft deflections are minimal, less than 0.2%, (0.002 mm/mm of length [0.002 inch/inch of length]), for highly loaded, very low speed applications, then the following misalignment considerations can be ignored.

Misalignment tests were conducted on GAR-MAX® bearings to determine the maximum edge stresses that may occur under varying amounts of misalignment. Figure 18 and Figure 19 show the relationship of the calculated edge stress, S_m , relative to the applied unit load P for two levels of misalignment (0.6% and 1.0%) and two length-to-diameter ratios ($B/D_i = 0.5$ and $B/D_i = 1.0$). For static loading, or static combined with shock loading, if the edge stress S_m exceeds the acceptable maximum of 345 N/mm² [50,000 psi] for GAR-MAX®, HPMB® and MLG or 517 N/mm² [75,000 psi] for HSG, then a redesign of the bearing is required.

GAR-FIL® is not recommended for applications when significant misalignment is anticipated.

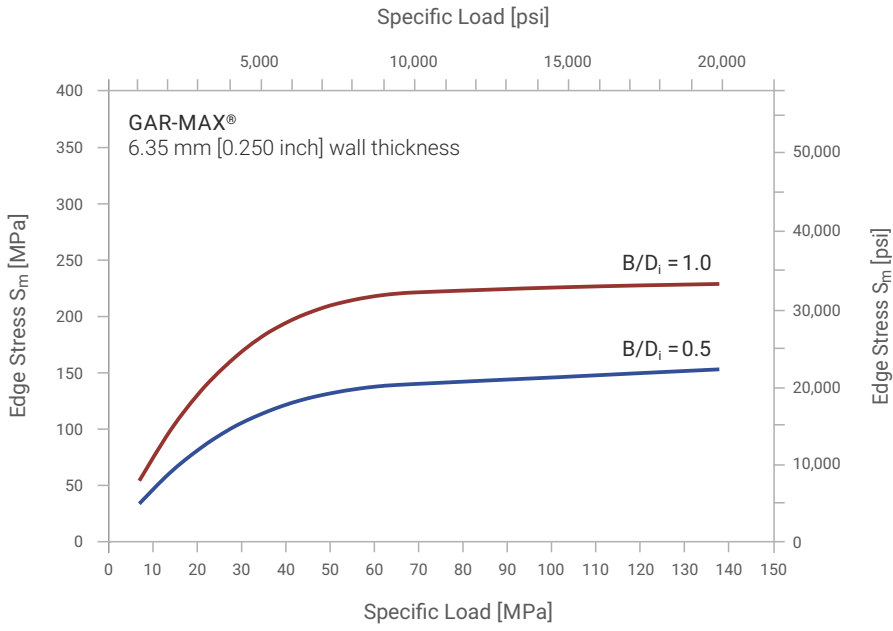

Fig. 18: Edge Stress for 0.6%

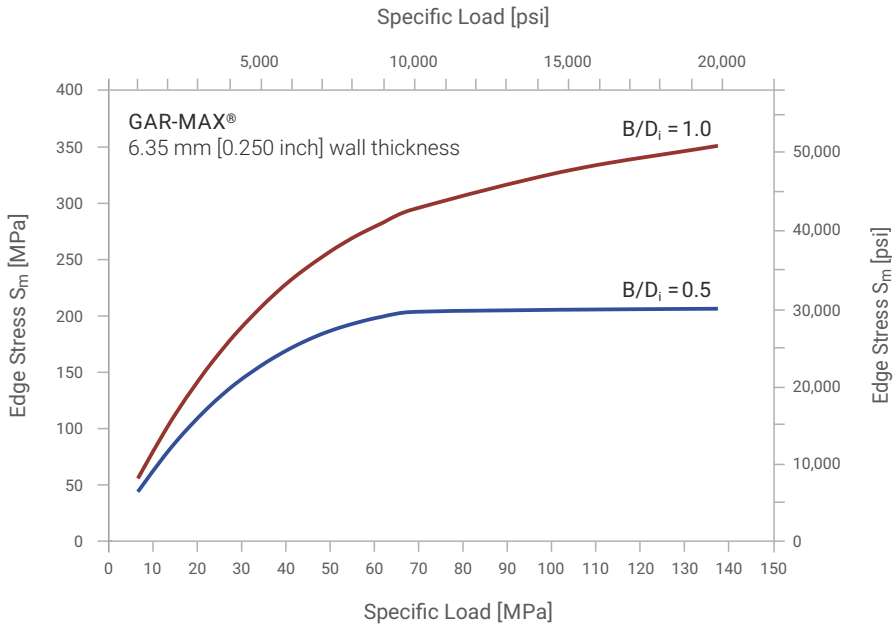

Fig. 19: Edge Stress for 1.0%

7 Installation and Machining

7.1 INSTALLATION

The retention of GGB fiber reinforced composite bearings in metal housings is excellent due to the high material stiffness and a thermal expansion rate similar to steel. The press fits used for bronze bearings are adequate for fiber reinforced composite bearings in most cases. In general, fiber reinforced composite bearings can be directly mounted in housings designed for bronze bearings. The bearing will close in by an amount equal to the measure of interference with the housing. This close-in must be considered when calculating the installed bore and corresponding shaft diameter.

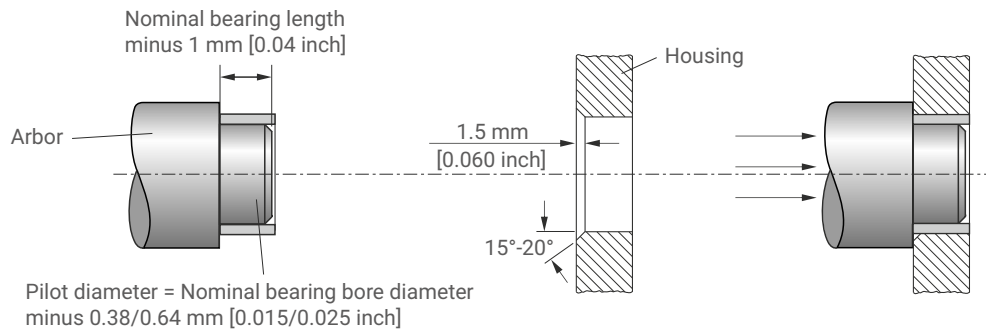

Fig. 20: Fitting of bearings

7.2 MACHINING OF HPMB® BEARINGS

The HPMB® bearing's liner is easily machined with commonly available single-point tools. In standard form, maximum allowable machining depth is 1 mm [0.04 inch] (on diameter), which can be increased up to 3 mm [0.118 inches] (on diameter) by special request.

HPMB® may be machined in a single pass to the required final inside diameter and it shall be machined dry. Documented machining parameters include carbide inserts with a cutting radius 3 - 10 mm [0.118 - 0.394 inches] to machine the liner with a surface speed of 1.25 - 3.5 m/s [0.049 - 0.138 inches] and a traverse speed of 0.13 mm [0.0005 inches] /revolution.

HPMB® bearings can be ID-machined either by GGB or the end user.

To obtain maximum bearing performance, it is strongly recommended that HPMB® bearings operate only after being machined in the inner diameter. The minimum recommended machining depth is 0.2 mm [0.008 inches] on the diameter.

7.3 FITTING

Length

Abrasive cut-off wheels produce the best results when cutting lengths of GGB fiber reinforced composite

When using a lathe to cut of lengths, we recommend using a carbide tool due to the abrasive nature of the fiberglass/epoxy outer shell.

Water mist or exhaust dust collectors should be used to minimize dust in the work area.

Outer Diameter

Grinding is the preferred method of altering the outer diameter; however, carbide lathe tools can also be used.

Inner Diameter

HPMB® bearing's liner is easily machined with a commonly available single point tools.

Please see Machining of HPMB® Bearings on page 44.

GAR-FIL® and HPF® bearings can be sized on the inner diameter. We recommend specifying 0.76 mm [0.030 inches] or thicker ape liner when ordering bearings that will be bored. When lathe boring a GAR-FIL® or HPF® bearing, you should first install the bearing into a rigid housing and bore using high speed and low feed rate. GAR-FIL® and HPF® bearings can also be reamed and broached.

Deburring

Emery cloth is effective in removing burrs from the outer diameter of GGB fiber reinforced composite bearings.

To remove frayed fibers from the ID of GAR-MAX®, HSG, MLG, HPMB® and HPM bearings, a small hand held grinder is preferred.

The inner diameter of GAR-FIL® or HPF® bearings can be deburred by a sharp cutting tool or emery cloth.

Drilling

Carbide drills should be used for drilling GGB fiber reinforced composite bearings.

When drilling GAR-MAX®, HSG, MLG, HPMB® and HPM bearings, the inner diameter must be supported with a mandrel, and a flat tipped drill or end mill should be used.

8 Standard Products

8.1 GAR-MAX®, GAR-FIL®, HSG, MLG (INCH SIZES)

1/8" Wall Series

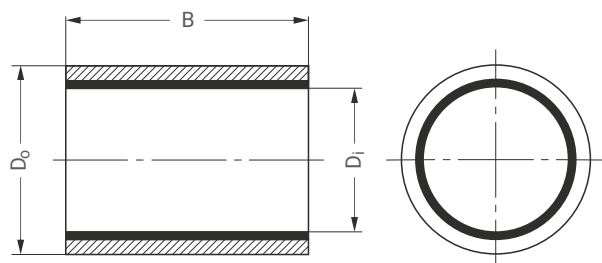

LENGTH TOLERANCE TABLE	B		
	< 3 inch	≥ 3 to < 6 inch	≥ 6 inch
D _i < 3 inch	± 0.01 inch	± 0.02 inch	± 0.03 inch
D _i ≥ 3 to < 6 inch	± 0.02 inch	± 0.02 inch	± 0.03 inch

To order, specify bearing product prefix and size number plus suffix for desired length (in multiples of 1/16").
e.g. GM2428-032 is a 1.5" ID x 1.75" OD x 2" long GAR-MAX® bearing.

BEARING PART NO. GM, GF, HSG, MLG	NOMINAL SIZE ID x OD / D _i x D _o	BEARING ID D _i	BEARING OD D _o	RECOMMENDED SIZES		BEARING CLEARANCE C _D
				SHAFT Ø D _J	Housing Ø D _H	
0812-xxx	1/2 x 3/4	0.5040	0.7535	0.5000	0.7500	0.0005
		0.5070	0.7515	0.4995	0.7505	0.0065
1014-xxx	5/8 x 7/8	0.6290	0.8785	0.6250	0.8750	0.0005
		0.6320	0.8765	0.6245	0.8755	0.0065
1216-xxx	3/4 x 1	0.7540	1.0035	0.7500	1.0000	0.0005
		0.7570	1.0015	0.7495	1.0005	0.0065
1418-xxx	7/8 x 1 1/8	0.8790	1.1285	0.8750	1.1250	0.0005
		0.8820	1.1265	0.8745	1.1255	0.0065
1620-xxx	1 x 1 1/4	1.0040	1.2535	1.0000	1.2500	0.0005
		1.0070	1.2515	0.9995	1.2505	0.0065
1822-xxx	1 1/8 x 1 3/8	1.1290	1.3785	1.1250	1.3750	0.0005
		1.1320	1.3765	1.1245	1.3755	0.0065
2024-xxx	1 1/4 x 1 1/2	1.2540	1.5035	1.2500	1.5000	0.0005
		1.2570	1.5015	1.2495	1.5005	0.0065
2226-xxx	1 3/8 x 1 5/8	1.3790	1.6285	1.3750	1.6250	0.0005
		1.3820	1.6265	1.3745	1.6255	0.0065
2428-xxx	1 1/2 x 1 3/4	1.5040	1.7535	1.5000	1.7500	0.0005
		1.5070	1.7515	1.4995	1.7505	0.0065
2630-xxx	1 5/8 x 1 7/8	1.6290	1.8785	1.6250	1.8750	0.0005
		1.6320	1.8765	1.6245	1.8755	0.0065
2832-xxx	1 3/4 x 2	1.7550	2.0035	1.7500	2.0000	0.0015
		1.7580	2.0015	1.7495	2.0005	0.0075
3034-xxx	1 7/8 x 2 1/8	1.8800	2.1285	1.8750	2.1250	0.0015
		1.8830	2.1265	1.8745	2.1255	0.0075
3236-xxx	2 x 2 1/4	2.0055	2.2545	2.0000	2.2500	0.0010
		2.0095	2.2525	1.9995	2.2510	0.0085
3438-xxx	2 1/8 x 2 1/4	2.1305	2.3795	2.1250	2.3750	0.0010
		2.1345	2.3775	2.1245	2.3760	0.0085
3640-xxx	2 1/4 x 2 1/2	2.2555	2.5045	2.2500	2.5000	0.0010
		2.2595	2.5025	2.2495	2.5010	0.0085
3842-xxx	2 3/8 x 2 5/8	2.3805	2.6295	2.3750	2.6250	0.0010
		2.3845	2.6275	2.3740	2.6260	0.0090

BEARING PART NO. GM, GF, HSG, MLG	NOMINAL SIZE ID x OD / D _I x D _O	BEARING ID D _I	BEARING OD D _O	RECOMMENDED SIZES		BEARING CLEARANCE C _D
				SHAFT Ø D _J	Housing Ø D _H	
4044-xxx	2 1/2 x 2 3/4	2.5060	2.7545	2.5000	2.7500	0.0015
		2.5100	2.7525	2.4990	2.7510	0.0095
4448-xxx	2 3/4 x 3	2.7560	3.0050	2.7500	3.0000	0.0010
		2.7600	3.0030	2.7490	3.0015	0.0095
4852-xxx	3 x 3 1/4	3.0065	3.2550	3.0000	3.2500	0.0015
		3.0105	3.2530	2.9990	3.2515	0.0100
5256-xxx	3 1/4 x 3 1/2	3.2565	3.5055	3.2500	3.5000	0.0010
		3.2605	3.5035	3.2490	3.5020	0.0100
5660-xxx	3 1/2 x 3 3/4	3.5065	3.7555	3.5000	3.7500	0.0010
		3.5105	3.7535	3.4990	3.7520	0.0100
6064-xxx	3 3/4 x 4	3.7565	4.0055	3.7500	4.0000	0.0010
		3.7605	4.0035	3.7490	4.0020	0.0100
6468-xxx	4 x 4 1/4	4.0090	4.2570	4.0000	4.2500	0.0020
		4.0140	4.2540	3.9990	4.2520	0.0130
6872-xxx	4 1/4 x 4 1/2	4.2590	4.5070	4.2500	4.5000	0.0020
		4.2640	4.5040	4.2490	4.5020	0.0130
7276-xxx	4 1/2 x 4 3/4	4.5090	4.7570	4.5000	4.7500	0.0020
		4.5140	4.7540	4.4990	4.7520	0.0130
7680-xxx	4 3/4 x 5	4.7590	5.0070	4.7500	5.0000	0.0020
		4.7640	5.0040	4.7490	5.0020	0.0130
8084-xxx	5 x 5 1/4	5.0090	5.2570	5.0000	5.2500	0.0020
		5.0140	5.2540	4.9990	5.2520	0.0130
8488-xxx	5 1/4 x 5 1/2	5.2590	5.5070	5.2500	5.5000	0.0020
		5.2640	5.5040	5.2490	5.5020	0.0130
8892-xxx	5 1/2 x 5 3/4	5.5090	5.7570	5.5000	5.7500	0.0020
		5.5140	5.7540	5.4990	5.7520	0.0130
9296-xxx	5 3/4 x 6	5.7590	6.0070	5.7500	6.0000	0.0020
		5.7640	6.0040	5.7490	6.0020	0.0130
96100-xxx	6 x 6 1/4	6.0120	6.2590	6.0000	6.2500	0.0030
		6.0180	6.2550	5.9985	6.2520	0.0165

All Dimensions in Inches. Additional sizes available - please consult with GGB for further details.



8 Standard Products

GAR-MAX®, GAR-FIL®, HSG, MLG (INCH SIZES)

1/4" Wall Series

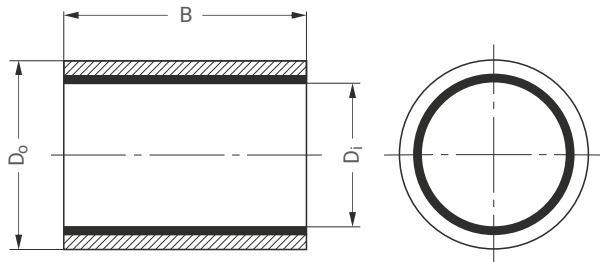

LENGTH TOLERANCE TABLE	B		
	< 3 inch	≥ 3 to < 6 inch	≥ 6 inch
D _i < 3 inch	± 0.01 inch	± 0.02 inch	± 0.03 inch
D _i ≥ 3 to < 6 inch	± 0.02 inch	± 0.02 inch	± 0.03 inch

To order, specify bearing product prefix and size number plus suffix for desired length (in multiples of 1/16").
e.g. GM2432-032 is a 1.5" ID x 2.0" OD x 2" long GAR-MAX® bearing.

BEARING PART NO. GM, GF, HSG, MLG	NOMINAL SIZE ID x OD / D _i x D _o	BEARING ID D _i	BEARING OD D _o	RECOMMENDED SIZES		BEARING CLEARANCE C _D
				SHAFT Ø D _J	Housing Ø D _H	
0816-xxx	1/2 x 1	0.5040	1.0035	0.5000	1.0000	0.0005
		0.5070	1.0015	0.4995	1.0005	0.0065
1018-xxx	5/8 x 1 1/8	0.6290	1.1285	0.6250	1.1250	0.0005
		0.6320	1.1265	0.6245	1.1255	0.0065
1220-xxx	3/4 x 1 1/4	0.7540	1.2535	0.7500	1.2500	0.0005
		0.7570	1.2515	0.7495	1.2505	0.0065
1422-xxx	7/8 x 1 3/8	0.8790	1.3785	0.8750	1.3750	0.0005
		0.8820	1.3765	0.8745	1.3755	0.0065
1624-xxx	1 x 1 1/2	1.0040	1.5035	1.0000	1.5000	0.0005
		1.0070	1.5015	0.9995	1.5005	0.0065
1826-xxx	1 1/8 x 1 5/8	1.1290	1.6285	1.1250	1.6250	0.0005
		1.1320	1.6265	1.1245	1.6255	0.0065
2028-xxx	1 1/4 x 1 3/4	1.2540	1.7535	1.2500	1.7500	0.0005
		1.2570	1.7515	1.2495	1.7505	0.0065
2230-xxx	1 3/8 x 1 7/8	1.3790	1.8785	1.3750	1.8750	0.0005
		1.3820	1.8765	1.3745	1.8755	0.0065
2432-xxx	1 1/2 x 2	1.5040	2.0035	1.5000	2.0000	0.0005
		1.5070	2.0015	1.4995	2.0005	0.0065
2634-xxx	1 5/8 x 2 1/8	1.6290	2.1285	1.6250	2.1250	0.0005
		1.6320	2.1265	1.6245	2.1255	0.0065
2836-xxx	1 3/4 x 2 1/4	1.7550	2.2545	1.7500	2.2500	0.0005
		1.7580	2.2525	1.7495	2.2510	0.0070
3038-xxx	1 7/8 x 2 3/8	1.8800	2.3795	1.8750	2.3750	0.0005
		1.8830	2.3775	1.8745	2.3760	0.0070
3240-xxx	2 x 2 1/2	2.0055	2.5045	2.0000	2.5000	0.0010
		2.0095	2.5025	1.9995	2.5010	0.0085
3442-xxx	2 1/8 x 2 5/8	2.1305	2.6295	2.1250	2.6250	0.0010
		2.1345	2.6275	2.1245	2.6260	0.0085
3644-xxx	2 1/4 x 2 3/4	2.2555	2.7545	2.2500	2.7500	0.0010
		2.2595	2.7525	2.2495	2.7510	0.0085
3846-xxx	2 3/8 x 2 7/8	2.3805	2.8795	2.3750	2.8750	0.0010
		2.3845	2.8775	2.3740	2.8760	0.0090

BEARING PART NO. GM, GF, HSG, MLG	NOMINAL SIZE ID x OD / D _i x D _o	BEARING ID D _i	BEARING OD D _o	RECOMMENDED SIZES		BEARING CLEARANCE C _D
				SHAFT Ø D _J	Housing Ø D _H	
4048-xxx	2 1/2 x 3	2.5060	3.0050	2.5000	3.0000	0.0010
		2.5100	3.0030	2.4990	3.0015	0.0095
4452-xxx	2 3/4 x 3 1/4	2.7560	3.2550	2.7500	3.2500	0.0010
		2.7600	3.2530	2.7490	3.2515	0.0095
4856-xxx	3 x 3 1/2	3.0065	3.5055	3.0000	3.5000	0.0010
		3.0105	3.5035	2.9990	3.5020	0.0100
5260-xxx	3 1/4 x 3 3/4	3.2565	3.7555	3.2500	3.7500	0.0010
		3.2605	3.7535	3.2490	3.7520	0.0100
5664-xxx	3 1/2 x 4	3.5065	4.0055	3.5000	4.0000	0.0010
		3.5105	4.0035	3.4990	4.0020	0.0100
6068-xxx	3 3/4 x 4 1/4	3.7565	4.2555	3.7500	4.2500	0.0010
		3.7605	4.2535	3.7490	4.2520	0.0100
6472-xxx	4 x 4 1/2	4.0090	4.5070	4.0000	4.5000	0.0020
		4.0140	4.5040	3.9990	4.5020	0.0130
6876-xxx	4 1/4 x 4 3/4	4.2590	4.7570	4.2500	4.7500	0.0020
		4.2640	4.7540	4.2490	4.7520	0.0130
7280-xxx	4 1/2 x 5	4.5090	5.0070	4.5000	5.0000	0.0020
		4.5140	5.0040	4.4990	5.0020	0.0130
7684-xxx	4 3/4 x 5 1/4	4.7590	5.2570	4.7500	5.2500	0.0020
		4.7640	5.2540	4.7490	5.2520	0.0130
8088-xxx	5 x 5 1/2	5.0090	5.5070	5.0000	5.5000	0.0020
		5.0140	5.5040	4.9990	5.5020	0.0130
8492-xxx	5 1/4 x 5 3/4	5.2590	5.7570	5.2500	5.7500	0.0020
		5.2640	5.7540	5.2490	5.7520	0.0130
8896-xxx	5 1/2 x 6	5.5090	6.0070	5.5000	6.0000	0.0020
		5.5140	6.0040	5.4990	6.0020	0.0130
92100-xxx	5 3/4 x 6 1/4	5.7590	6.2570	5.7500	6.2500	0.0020
		5.7640	6.2540	5.7490	6.2520	0.0130
96104-xxx	6 x 6 1/2	6.0120	6.5090	6.0000	6.5000	0.0030
		6.0180	6.5050	5.9985	6.5020	0.0165

All Dimensions in Inches. Additional sizes available - please consult with GGB for further details.



8 Standard Products

8.2 GAR-MAX®, GAR-FIL®, HSG, MLG (METRIC SIZES)

2.5 mm Wall Series

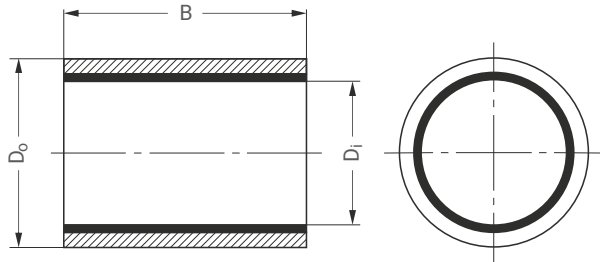

LENGTH TOLERANCE TABLE	B		
	< 75 mm	≥ 75 to < 150 mm	≥ 150 mm
D _i < 75 mm	- 0.5 mm	- 1.0 mm	- 1.5 mm
D _i ≥ 75 to < 150 mm	- 1.0 mm	- 1.0 mm	- 1.5 mm

To order, specify bearing ID, OD and length size number (in millimeters) plus product suffix.
e.g. 253020GM is a 25 mm ID x 30 mm OD x 20 mm long GAR-MAX® bearing.

BEARING PART NO. GM, GF, HSG, MLG	NOMINAL SIZE ID x OD / D _i x D _o	BEARING ID D _i	BEARING OD D _o	RECOMMENDED SIZES		BEARING CLEARANCE C _D
				SHAFT Ø D _J	Housing Ø D _H	
1217xx	12 x 17	12.110	17.090	12.000	17.000	0.020
		12.190	17.040	11.973	17.018	0.195
1520xx	15 x 20	15.110	20.090	15.000	20.000	0.020
		15.190	20.040	14.973	20.021	0.198
1621xx	16 x 21	16.110	21.090	16.000	21.000	0.020
		16.190	21.040	15.973	21.021	0.198
1823xx	18 x 23	18.110	23.090	18.000	23.000	0.020
		18.190	23.040	17.973	23.021	0.198
2025xx	20 x 25	20.110	25.090	20.000	25.000	0.020
		20.190	25.040	19.967	25.021	0.204
2227xx	22 x 27	22.110	27.090	22.000	27.000	0.020
		22.190	27.040	21.967	27.021	0.204
2530xx	25 x 30	25.110	30.090	25.000	30.000	0.020
		25.190	30.040	24.967	30.021	0.204
2833xx	28 x 33	28.115	33.095	28.000	33.000	0.020
		28.195	33.045	27.967	33.025	0.208
3035xx	30 x 35	30.115	35.095	30.000	35.000	0.020
		30.195	35.045	29.967	35.025	0.208
3540xx	35 x 40	35.115	40.095	35.000	40.000	0.020
		35.195	40.045	34.961	40.025	0.214
4045xx	40 x 45	40.115	45.095	40.000	45.000	0.020
		40.195	45.045	39.961	45.025	0.214
4550xx	45 x 50	45.125	50.100	45.000	50.000	0.025
		45.225	50.050	44.961	50.025	0.239
5055xx	50 x 55	50.125	55.100	50.000	55.000	0.025
		50.225	55.055	49.961	55.030	0.239
5560xx	55 x 60	55.140	60.115	55.000	60.000	0.025
		55.240	60.065	54.954	60.030	0.251
6065xx	60 x 65	60.140	65.115	60.000	65.000	0.025
		60.240	65.065	59.954	65.030	0.251
6570xx	65 x 70	65.140	70.115	65.000	70.000	0.025
		65.240	70.065	64.954	70.030	0.251

BEARING PART NO. GM, GF, HSG, MLG	NOMINAL SIZE ID x OD / D _i x D _o	BEARING ID D _i	BEARING OD D _o	RECOMMENDED SIZES		BEARING CLEARANCE C _D
				SHAFT Ø D _J	Housing Ø D _H	
7075xx	70 x 75	70.145	75.115	70.000	75.000	0.030
		70.245	75.065	69.954	75.030	0.256
7580xx	75 x 80	75.165	80.125	75.000	80.000	0.040
		75.265	80.070	74.954	80.030	0.271
8085xx	80 x 85	80.165	85.125	80.000	85.000	0.040
		80.265	85.075	79.954	85.035	0.271
8590xx	85 x 90	85.165	90.125	85.000	90.000	0.040
		85.265	90.075	84.946	90.035	0.279
9095xx	90 x 95	90.175	95.135	90.000	95.000	0.040
		90.275	95.085	89.946	95.035	0.279
9510xx	95 x 100	95.175	100.135	95.000	100.000	0.040
		95.300	100.085	94.946	100.035	0.304
100105xx	100 x 105	100.175	105.135	100.000	105.000	0.040
		100.300	105.085	99.946	105.035	0.304
110115xx	110 x 115	110.175	115.135	110.000	115.000	0.040
		110.300	115.080	109.946	115.035	0.309
120125xx	120 x 125	120.205	125.165	120.000	125.000	0.040
		120.330	125.105	119.946	125.040	0.319
130135xx	130 x 135	130.205	135.165	130.000	135.000	0.040
		130.330	135.090	129.937	135.040	0.343
140145xx	140 x 145	140.205	145.165	140.000	145.000	0.040
		140.330	145.090	139.937	145.040	0.343
150155xx	150 x 155	150.205	155.165	150.000	155.000	0.040
		150.330	155.090	149.937	155.040	0.343

All Dimensions in Millimeters. Additional sizes available - please consult with GGB for further details.



8 Standard Products

GAR-MAX®, GAR-FIL®, HSG, MLG (METRIC SIZES)

5 mm Wall Series

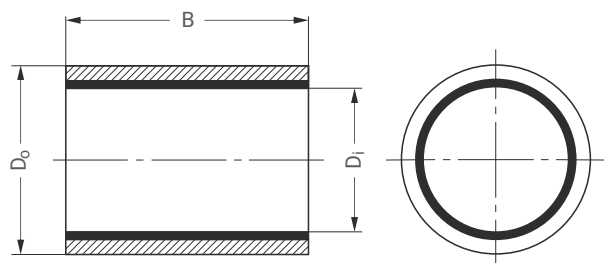

LENGTH TOLERANCE TABLE	B		
	< 75 mm	≥ 75 to < 150 mm	≥ 150 mm
D _i < 75 mm	- 0.5 mm	- 1.0 mm	- 1.5 mm
D _i ≥ 75 to < 150 mm	- 1.0 mm	- 1.0 mm	- 1.5 mm

To order, specify bearing ID, OD and length size number (in millimeters) plus product suffix.
e.g. 253520GM is a 25 mm ID x 30 mm OD x 20 mm long GAR-MAX® bearing.

BEARING PART NO. GM, GF, HSG, MLG	NOMINAL SIZE ID x OD / D _i x D _o	BEARING ID D _i	BEARING OD D _o	RECOMMENDED SIZES		BEARING CLEARANCE C _D
				SHAFT Ø D _J	Housing Ø D _H	
1222xx	12 x 22	12.110	22.090	12.000	22.000	0.020
		12.190	22.040	11.973	22.021	0.198
1525xx	15 x 25	15.110	25.090	15.000	25.000	0.020
		15.190	25.040	14.973	25.021	0.198
1626xx	16 x 26	16.110	26.090	16.000	26.000	0.020
		16.190	26.040	15.973	26.021	0.198
1828xx	18 x 28	18.110	28.090	18.000	28.000	0.020
		18.190	28.040	17.973	28.021	0.198
2030xx	20 x 30	20.110	30.090	20.000	30.000	0.020
		20.190	30.040	19.967	30.021	0.204
2232xx	22 x 32	22.115	32.095	22.000	32.000	0.020
		22.195	32.045	21.967	32.025	0.208
2535xx	25 x 35	25.115	35.095	25.000	35.000	0.020
		25.195	35.045	24.967	35.025	0.208
2838xx	28 x 38	28.115	38.095	28.000	38.000	0.020
		28.195	38.045	27.967	38.025	0.208
3040xx	30 x 40	30.115	40.095	30.000	40.000	0.020
		30.195	40.045	29.967	40.025	0.208
3545xx	35 x 45	35.115	45.095	35.000	45.000	0.020
		35.195	45.045	34.961	45.025	0.214
4050xx	40 x 50	40.115	50.095	40.000	50.000	0.020
		40.195	50.045	39.961	50.025	0.214
4555xx	45 x 55	45.130	55.105	45.000	55.000	0.025
		45.230	55.055	44.961	55.030	0.244
5060xx	50 x 60	50.130	60.105	50.000	60.000	0.025
		50.230	60.055	49.961	60.030	0.244
5565xx	55 x 65	55.140	65.115	55.000	65.000	0.025
		55.240	65.065	54.954	65.030	0.251
6070xx	60 x 70	60.140	70.115	60.000	70.000	0.025
		60.240	70.065	59.954	70.030	0.251
6575xx	65 x 75	65.140	75.115	65.000	75.000	0.025
		65.240	75.065	64.954	75.030	0.251

BEARING PART NO. GM, GF, HSG, MLG	NOMINAL SIZE ID x OD / D _i x D _o	BEARING ID D _i	BEARING OD D _o	RECOMMENDED SIZES		BEARING CLEARANCE C _D
				SHAFT Ø D _J	Housing Ø D _H	
7080xx	70 x 80	70.145	80.115	70.000	80.000	0.030
		70.245	80.065	69.954	80.030	0.256
7585xx	75 x 85	75.165	85.125	75.000	85.000	0.040
		75.265	85.075	74.954	85.035	0.271
8090xx	80 x 90	80.165	90.125	80.000	90.000	0.040
		80.265	90.075	79.954	90.035	0.271
8595xx	85 x 95	85.165	95.125	85.000	95.000	0.040
		85.265	95.075	84.946	95.035	0.279
90100xx	90 x 100	90.175	100.135	90.000	100.000	0.040
		90.275	100.085	89.946	100.035	0.279
95105xx	95 x 105	95.175	105.135	95.000	105.000	0.040
		95.300	105.085	94.946	105.035	0.304
100110xx	100 x 110	100.175	110.135	100.000	110.000	0.040
		100.300	110.085	99.946	110.035	0.304
110120xx	110 x 120	110.175	120.135	110.000	120.000	0.040
		110.300	120.085	109.946	120.035	0.304
120130xx	120 x 130	120.205	130.165	120.000	130.000	0.040
		120.330	130.090	119.946	130.040	0.334
130140xx	130 x 140	130.205	140.165	130.000	140.000	0.040
		130.330	140.090	129.937	140.040	0.343
140150xx	140 x 150	140.205	150.165	140.000	150.000	0.040
		140.330	150.090	139.937	150.040	0.343
150160xx	150 x 160	150.205	160.165	150.000	160.000	0.040
		150.330	160.090	149.937	160.040	0.343

All Dimensions in Millimeters. Additional sizes available - please consult with GGB for further details.



8 Standard Products

8.3 EUROPEAN GAR-MAX® SIZE RANGE

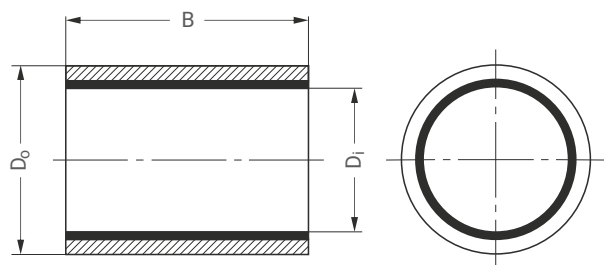

LENGTH TOLERANCE TABLE	B		
	< 75 mm	≥ 75 to < 150 mm	≥ 150 mm
D _i < 75 mm	- 0.5 mm	- 1.0 mm	- 1.5 mm
D _i ≥ 75 to < 150 mm	- 1.0 mm	- 1.0 mm	- 1.5 mm

To order, specify bearing ID, OD and length size number (in millimeters) plus product suffix.
e.g. 253020GM is a 25 mm ID x 30 mm OD x 20 mm long GAR-MAX® bearing.

BEARING PART NO.	NOMINAL SIZE ID x OD x Length/ D _i x D _o x B	BEARING ID D _i	BEARING OD D _o	SHAFT, h8	HOUSING, H7	CLEARANCE (AFTER ASSEMBLY in H7 HOUSING)
162015GM	16 x 20 x 15	16.110 / 16.190	20.090 / 20.040	16.000 / 15.973	20.000 / 20.021	0.020 / 0.198
162020GM	16 x 20 x 20	16.110 / 16.190	20.090 / 20.040	16.000 / 15.973	20.000 / 20.021	0.020 / 0.198
202415GM	20 x 24 x 15	20.110 / 20.190	24.090 / 24.040	20.000 / 19.967	24.000 / 24.021	0.020 / 0.204
202420GM	20 x 24 x 20	20.110 / 20.190	24.090 / 24.040	20.000 / 19.967	24.000 / 24.021	0.020 / 0.204
202425GM	20 x 24 x 25	20.110 / 20.190	24.090 / 24.040	20.000 / 19.967	24.000 / 24.021	0.020 / 0.204
222620GM	22 x 26 x 20	22.110 / 22.190	26.090 / 26.040	22.000 / 21.967	26.000 / 26.021	0.020 / 0.204
222625GM	22 x 26 x 25	22.110 / 22.190	26.090 / 26.040	22.000 / 21.967	26.000 / 26.021	0.020 / 0.204
253020GM	25 x 30 x 20	25.110 / 25.190	30.090 / 30.040	25.000 / 24.967	30.000 / 30.021	0.020 / 0.204
253025GM	25 x 30 x 25	25.110 / 25.190	30.090 / 30.040	25.000 / 24.967	30.000 / 30.021	0.020 / 0.204
253030GM	25 x 30 x 30	25.110 / 25.190	30.090 / 30.040	25.000 / 24.967	30.000 / 30.021	0.020 / 0.204
283422GM	28 x 34 x 22	28.115 / 28.195	34.095 / 34.045	28.000 / 27.967	34.000 / 34.025	0.020 / 0.208
303620GM	30 x 36 x 20	30.115 / 30.195	36.095 / 36.045	30.000 / 29.967	36.000 / 36.025	0.020 / 0.208
303630GM	30 x 36 x 30	30.115 / 30.195	36.095 / 36.045	30.000 / 29.967	36.000 / 36.025	0.020 / 0.208
303636GM	30 x 36 x 36	30.115 / 30.195	36.095 / 36.045	30.000 / 29.967	36.000 / 36.025	0.020 / 0.208
303640GM	30 x 36 x 40	30.115 / 30.195	36.095 / 36.045	30.000 / 29.967	36.000 / 36.025	0.020 / 0.208
303650GM	30 x 36 x 50	30.115 / 30.195	36.095 / 36.045	30.000 / 29.967	36.000 / 36.025	0.020 / 0.208
354130GM	35 x 41 x 30	35.115 / 35.195	41.095 / 41.045	35.000 / 34.961	41.000 / 41.025	0.020 / 0.214
354135GM	35 x 41 x 35	35.115 / 35.195	41.095 / 41.045	35.000 / 34.961	41.000 / 41.025	0.020 / 0.214
354140GM	35 x 41 x 40	35.115 / 35.195	41.095 / 41.045	35.000 / 34.961	41.000 / 41.025	0.020 / 0.214
354150GM	35 x 41 x 50	35.115 / 35.195	41.095 / 41.045	35.000 / 34.961	41.000 / 41.025	0.020 / 0.214
404820GM	40 x 48 x 20	40.115 / 40.195	48.095 / 48.045	40.000 / 39.961	48.000 / 48.025	0.020 / 0.214
404830GM	40 x 48 x 30	40.115 / 40.195	48.095 / 48.045	40.000 / 39.961	48.000 / 48.025	0.020 / 0.214
404840GM	40 x 48 x 40	40.115 / 40.195	48.095 / 48.045	40.000 / 39.961	48.000 / 48.025	0.020 / 0.214
404850GM	40 x 48 x 50	40.115 / 40.195	48.095 / 48.045	40.000 / 39.961	48.000 / 48.025	0.020 / 0.214
455330GM	45 x 53 x 30	45.130 / 45.230	53.105 / 53.055	45.000 / 44.961	53.000 / 53.030	0.025 / 0.244
455340GM	45 x 53 x 40	45.130 / 45.230	53.105 / 53.055	45.000 / 44.961	53.000 / 53.030	0.025 / 0.244
455345GM	45 x 53 x 45	45.130 / 45.230	53.105 / 53.055	45.000 / 44.961	53.000 / 53.030	0.025 / 0.244
455350GM	45 x 53 x 50	45.130 / 45.230	53.105 / 53.055	45.000 / 44.961	53.000 / 53.030	0.025 / 0.244
455360GM	45 x 53 x 60	45.130 / 45.230	53.105 / 53.055	45.000 / 44.961	53.000 / 53.030	0.025 / 0.244

BEARING PART NO.	NOMINAL SIZE ID x OD x Length/ D _i x D _o x B	BEARING ID D _i	BEARING OD D _o	SHAFT, h8	HOUSING, H7	CLEARANCE (AFTER ASSEMBLY in H7 HOUSING)
505830GM	50 x 58 x 30	50.130 / 50.230	58.105 / 58.055	50.000 / 49.961	58.000 / 58.030	0.025 / 0.244
505840GM	50 x 58 x 40	50.130 / 50.230	58.105 / 58.055	50.000 / 49.961	58.000 / 58.030	0.025 / 0.244
505850GM	50 x 58 x 50	50.130 / 50.230	58.105 / 58.055	50.000 / 49.961	58.000 / 58.030	0.025 / 0.244
505860GM	50 x 58 x 60	50.130 / 50.230	58.105 / 58.055	50.000 / 49.961	58.000 / 58.030	0.025 / 0.244
556330GM	55 x 63 x 30	55.140 / 55.240	63.115 / 63.065	55.000 / 54.954	63.000 / 63.030	0.025 / 0.251
556340GM	55 x 63 x 40	55.140 / 55.240	63.115 / 63.065	55.000 / 54.954	63.000 / 63.030	0.025 / 0.251
556360GM	55 x 63 x 60	55.140 / 55.240	63.115 / 63.065	55.000 / 54.954	63.000 / 63.030	0.025 / 0.251
607030GM	60 x 70 x 30	60.140 / 60.240	70.115 / 70.065	60.000 / 59.954	70.000 / 70.030	0.025 / 0.251
607040GM	60 x 70 x 40	60.140 / 60.240	70.115 / 70.065	60.000 / 59.954	70.000 / 70.030	0.025 / 0.251
607045GM	60 x 70 x 45	60.140 / 60.240	70.115 / 70.065	60.000 / 59.954	70.000 / 70.030	0.025 / 0.251
607050GM	60 x 70 x 50	60.140 / 60.240	70.115 / 70.065	60.000 / 59.954	70.000 / 70.030	0.025 / 0.251
607060GM	60 x 70 x 60	60.140 / 60.240	70.115 / 70.065	60.000 / 59.954	70.000 / 70.030	0.025 / 0.251
657550GM	65 x 75 x 50	65.140 / 65.240	75.115 / 75.065	65.000 / 64.954	75.000 / 75.030	0.025 / 0.251
708040GM	70 x 80 x 40	70.145 / 70.245	80.115 / 80.065	70.000 / 69.954	80.000 / 80.030	0.030 / 0.256
708050GM	70 x 80 x 50	70.145 / 70.245	80.115 / 80.065	70.000 / 69.954	80.000 / 80.030	0.030 / 0.256
708055GM	70 x 80 x 55	70.145 / 70.245	80.115 / 80.065	70.000 / 69.954	80.000 / 80.030	0.030 / 0.256
708060GM	70 x 80 x 60	70.145 / 70.245	80.115 / 80.065	70.000 / 69.954	80.000 / 80.030	0.030 / 0.256
708070GM	70 x 80 x 70	70.145 / 70.245	80.115 / 80.065	70.000 / 69.954	80.000 / 80.030	0.030 / 0.256
708080GM	70 x 80 x 80	70.145 / 70.245	80.115 / 80.065	70.000 / 69.954	80.000 / 80.030	0.030 / 0.256
758550GM	75 x 85 x 50	75.165 / 75.265	85.125 / 85.075	75.000 / 74.954	85.000 / 85.035	0.040 / 0.271
758560GM	75 x 85 x 60	75.165 / 75.265	85.125 / 85.075	75.000 / 74.954	85.000 / 85.035	0.040 / 0.271
758570GM	75 x 85 x 70	75.165 / 75.265	85.125 / 85.075	75.000 / 74.954	85.000 / 85.035	0.040 / 0.271
758580GM	75 x 85 x 80	75.165 / 75.265	85.125 / 85.075	75.000 / 74.954	85.000 / 85.035	0.040 / 0.271
809050GM	80 x 90 x 50	80.165 / 80.265	90.125 / 90.075	80.000 / 79.954	90.000 / 90.035	0.040 / 0.271
809060GM	80 x 90 x 60	80.165 / 80.265	90.125 / 90.075	80.000 / 79.954	90.000 / 90.035	0.040 / 0.271
809070GM	80 x 90 x 70	80.165 / 80.265	90.125 / 90.075	80.000 / 79.954	90.000 / 90.035	0.040 / 0.271
809080GM	80 x 90 x 80	80.165 / 80.265	90.125 / 90.075	80.000 / 79.954	90.000 / 90.035	0.040 / 0.271
859560GM	85 x 95 x 60	85.165 / 85.265	95.125 / 95.075	85.000 / 84.946	95.000 / 95.035	0.040 / 0.279
859580GM	85 x 95 x 80	85.165 / 85.265	95.125 / 95.075	85.000 / 84.946	95.000 / 95.035	0.040 / 0.279
9010570GM	90 x 105 x 70	90.175 / 90.275	105.135 / 105.085	90.000 / 89.946	105.000 / 105.035	0.040 / 0.279
10011580GM	100 x 115 x 80	100.175 / 100.300	115.135 / 115.085	100.000 / 99.946	115.000 / 115.035	0.040 / 0.304
100115100GM	100 x 115 x 100	100.175 / 100.300	115.135 / 115.085	100.000 / 99.946	115.000 / 115.035	0.040 / 0.304
100115120GM	100 x 115 x 120	100.175 / 100.300	115.135 / 115.085	100.000 / 99.946	115.000 / 115.035	0.040 / 0.304
110125100GM	110 x 125 x 100	110.205 / 110.330	125.165 / 125.090	110.000 / 109.946	125.000 / 125.040	0.040 / 0.334
110125120GM	110 x 125 x 120	110.205 / 110.330	125.165 / 125.090	110.000 / 109.946	125.000 / 125.040	0.040 / 0.334
120135100GM	120 x 135 x 100	120.205 / 120.330	135.165 / 135.090	120.000 / 119.946	135.000 / 135.040	0.040 / 0.334
120135120GM	120 x 135 x 120	120.205 / 120.330	135.165 / 135.090	120.000 / 119.946	135.000 / 135.040	0.040 / 0.334

All Dimensions in Millimeters. Additional sizes available - please consult with GGB for further details.

8 Standard Products

8.4 GGB-MEGALIFE™ XT THRUST WASHERS, INCH SIZES

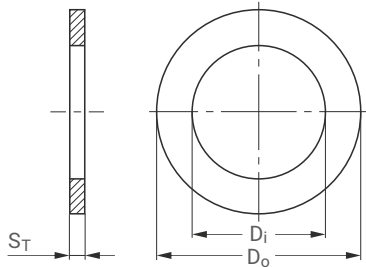

To order, specify MWXT size number plus suffix for desired thickness (062, 080, 125).
e.g. MWXT1632-080 is a 1" ID x 2" OD x 0.080" thick GGB-MEGALIFE™ XT thrust washer.

BEARING PART NO.	NOMINAL SIZE ID x OD / D _i x D _o	NOMINAL THICKNESS S _T
MWXT0816-xxx	1/2 x 1	0.062 · 0.080
MWXT1020-xxx	5/8 x 1 1/4	0.062 · 0.080 · 0.125
MWXT1224-xxx	3/4 x 1 1/2	0.062 · 0.080 · 0.125
MWXT1428-xxx	7/8 x 1 3/4	0.062 · 0.080 · 0.125
MWXT1632-xxx	1 x 2	0.062 · 0.080 · 0.125
MWXT1834-xxx	1 1/8 x 2 1/8	0.062 · 0.080 · 0.125
MWXT2036-xxx	1 1/4 x 2 1/4	0.062 · 0.080 · 0.125
MWXT2238-xxx	1 3/8 x 2 3/8	0.062 · 0.080 · 0.125
MWXT2440-xxx	1 1/2 x 2 1/2	0.062 · 0.080 · 0.125
MWXT2642-xxx	1 5/8 x 2 5/8	0.062 · 0.080 · 0.125
MWXT2844-xxx	1 3/4 x 2 3/4	0.062 · 0.080 · 0.125
MWXT3248-xxx	2 x 3	0.062 · 0.080 · 0.125
MWXT3652-xxx	2 1/4 x 3 1/4	0.062 · 0.080 · 0.125
MWXT4060-xxx	2 1/2 x 3 3/4	0.062 · 0.080 · 0.125
MWXT4464-xxx	2 3/4 x 4	0.062 · 0.080 · 0.125
MWXT4872-xxx	3 x 4 1/2	0.062 · 0.080 · 0.125

All Dimensions in Inches.
Additional sizes available - please consult with GGB for further details.



8.5 GGB-MEGALIFE™ XT THRUST WASHERS, METRIC SIZES

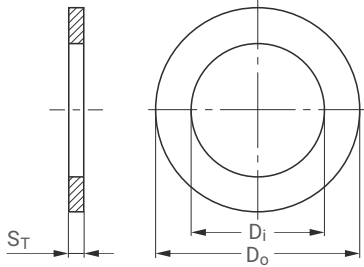

To order, specify MWXT size number plus suffix for desired thickness (15, 20, 30).
 e.g. MWXTM2244-20 is a 22 mm ID x 44 mm OD x 2 mm thick GGB-MEGALIFE™ XT thrust washer.

BEARING PART NO.	NOMINAL SIZE ID x OD / D _i x D _o	NOMINAL THICKNESS S _T
MWXTM1224-xx	12 x 24	1.5 · 2.0
MWXTM1530-xx	15 x 30	1.5 · 2.0 · 3.0
MWXTM1836-xx	18 x 36	1.5 · 2.0 · 3.0
MWXTM2040-xx	20 x 40	1.5 · 2.0 · 3.0
MWXTM2244-xx	22 x 44	1.5 · 2.0 · 3.0
MWXTM2550-xx	25 x 50	1.5 · 2.0 · 3.0
MWXTM3055-xx	30 x 55	1.5 · 2.0 · 3.0
MWXTM3560-xx	35 x 60	1.5 · 2.0 · 3.0
MWXTM4065-xx	40 x 65	1.5 · 2.0 · 3.0
MWXTM4570-xx	45 x 70	1.5 · 2.0 · 3.0
MWXTM5075-xx	50 x 75	1.5 · 2.0 · 3.0
MWXTM5580-xx	55 x 80	1.5 · 2.0 · 3.0
MWXTM6085-xx	60 x 85	1.5 · 2.0 · 3.0
MWXTM6595-xx	65 x 95	1.5 · 2.0 · 3.0
MWXTM70100-xx	70 x 100	1.5 · 2.0 · 3.0
MWXTM75115-xx	75 x 115	1.5 · 2.0 · 3.0

All Dimensions in Millimeters.
 Additional sizes available - please consult with GGB for further details.

9 Bearing Application Data Sheet

Please complete the form below and share it with your GGB sales engineer or send it to: usa@ggbearings.com

DATA FOR BEARING DESIGN CALCULATION

Application: _____

Project/No.: _____ Quantity: _____ New Design Existing Design

Steady load Rotating load Rotational movement Oscillating movement Linear movement

DIMENSIONS [MM]

Inside diameter	D_i
Outside diameter	D_o
Length	B
Flange Diameter	D_{fl}
Flange thickness	B_{fl}
Wall thickness	S_T
Length of slideplate	L
Width of slideplate	W
Thickness of slideplate	S_s

LOAD

Static load
 Dynamic load

Axial load F	[N]
Radial load F	[N]

MOVEMENT

Rotational speed	N [1/min]
Speed	U [m/s]
Length of stroke	L_s [mm]
Frequency of stroke	[1/min]
Oscillating cycle	ϕ [°]
Osc. frequency	N_{osz} [1/min]

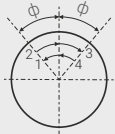

MATING SURFACE

Material	
Hardness	HB/HRC
Surface finish	Ra [µm]

CUSTOMER INFORMATION

Company _____
 Street _____
 City / State / Province / Post Code _____
 Telephone _____ Fax _____
 Name _____
 Email Address _____ Date _____

FITS & TOLERANCES

Shaft	D_j
Bearing housing	D_H

OPERATING ENVIRONMENT

Ambient temperature	T_{amb} [°]
Bearing housing material	

Housing with good heating transfer properties
 Light pressing or insulated housing with poor heat transfer properties
 Non metal housing with poor heat transfer properties
 Alternate operation in water and dry

LUBRICATION

Dry
 Continuous lubrication
 Process fluid lubrication
 Initial lubrication only
 Hydrodynamic conditions

Process fluid	
Lubricant	
Dynamic viscosity	η [mPas]

SERVICE HOURS PER DAY

Continuous operation	
Intermittent operation	
Operating time	
Days per year	

SERVICE LIFE

Required service life	L_H [h]
-----------------------	-----------

BEARING TYPE

Cylindrical bush

Flanged bush

Thrust washer

Slideplate

Special parts (sketch)

FORMULA SYMBOLS AND DESIGNATIONS

SYMBOL	UNIT SI	UNIT ANSI	DESIGNATION
a _B	-	-	Bearing size factor
a _E	-	-	High load factor
a _M	-	-	Mating material factor
a _S	-	-	Surface inish factor
a _T	-	-	Temperature application factor
B	mm	in	Nominal bush length
C _D	mm	in	Installed diametrical clearance
D _H	mm	in	Housing diameter
D _i	mm	in	Nominal bush ID Nominal thrust washer ID
D _o	mm	in	Nominal bush OD Nominal thrust washer OD
D _J	mm	in	Shaft diameter
E	MPa	lbf/in ²	Young's Modulus
F	N	lbs	Bearing load
L _Y	-	-	Bearing service life, years
L _Q	-	-	Bearing service life, cycles
N	1/min	1/min	Rotational speed
N _{OSC}	1/min	1/min	Rotational speed for oscillating motion
p	MPa	lbf/in ²	Specific load
p _{lim}	MPa	lbf/in ²	Specific load limit
p _{sta,max}	MPa	lbf/in ²	Maximum static load
p _{dyn,max}	MPa	lbf/in ²	Maximum dynamic load

UNIT CONVERSIONS

SI to ANSI Conversions

1 mm	0.0394 in
1 m	3.2808 ft
1 Newton = 1N	0.225 lbs
1 MPa = 1 N/mm ²	145 lbf/in ²
1 m/s	196.85 ft/min
°C	(°F-32)/1.8

ANSI to SI Conversions

1 in	25.4 mm
1 ft	0.3048
1 lbf	4.448 N
1 lbf/in ²	0.0069 MPa = 0.0069 N/mm ²
1 fpm	0.0051 m/s
°F	(1,8 x °C) + 32

SYMBOL	UNIT SI	UNIT ANSI	DESIGNATION
Q _{GF}	-	-	GAR-FIL® cyclic life factor
Q _{GM}	-	-	GAR-MAX®, HSG cyclic life factor
Q _{MLG}	-	-	MLG cyclic life factor
R _a	µm	µin	Surface roughness (DIN 4768, ISO/DIN 4287/1)
S _M	MPa	psi	Calculated edge stress
S _S	mm	in	Thickness of sliding plate
S _T	mm	in	Thickness of washer
T	°C	°F	Temperature
T _{amb}	°C	°F	Ambient temperature
T _{max}	°C	°F	Maximum temperature
T _{min}	°C	°F	Minimum temperature
U	m/s	ft/min	Sliding speed
U _{lim}	m/s	ft/min	Maximum sliding speed
f	-	-	Coefficient of friction
α ₁	1/10 ⁶ K	1/10 ⁶ K	Coefficient of linear Thermal expansion
σ	MPa	lbf/in ²	Compressive Yield strength
φ	°	°	Angular displacement

mm = millimeters

m = meters

ft = foot

in = inch

N = Newtons

W = Watts

MPa = MegaPascal = N/mm²

lbf = pounds force

psi = pounds per square inch

min = minute

hr = hour

ft/min = feet per minute

m/s = meters per second

°F = degrees Fahrenheit

°C = degrees Celcius

°K = degrees Kelvin

BTU = British Thermal Units

10 Other GGB Bearing Products

POLYMER COATINGS



GGB's TriboShield® product line includes seven standard formulations that cover the full spectrum of mechanical, thermal and chemical capabilities offered by today's polymer materials. Our TriboShield® polymer coatings can be applied to nearly any surface, regardless of shape or material, making their potential almost endless.

METAL-POLYMER BEARINGS



The excellent low friction and high wear resistance performance of GGB metal-polymer bearings make them ideal for hundreds of applications in numerous and diverse industries. Depending upon application requirements, metal-polymer composite bearings can be produced in many shapes and sizes.

ENGINEERED PLASTIC BEARINGS



GGB's Engineered Plastic Polymer bearings provide excellent wear resistance and low friction in both dry and lubricated operating conditions over a wide range of applications. Engineered plastic bearings are made from thermoplastic bearing material processed by injection moulding. This production method enables us to produce unlimited dimensions in accordance to our standard, and also parts with special designs and features.

METAL AND BIMETAL BEARINGS



Bimetal and metal bearings offer excellent corrosion resistance in industrial outdoor applications and in water, marine and offshore environments. GGB offers a broad range of sizes, forms and materials in monometallic and bimetallic bearings.

BEARING ASSEMBLIES



Engineered as a solution to conquer misalignment reduction when high demands are placed on bearings, GGB's UNI, MINI and EXALIGN® self-aligning shaft bearing assemblies offer improved equipment performance under standard bearing assemblies by reducing stress and friction. Offering superior performance in a wide variety of applications, GGB's self-aligning assemblies are available in both standard and custom configurations.

11 Product Information

GGB assures the products described in this document have no manufacturing errors or material deficiencies.

The details set out in this document are registered to assist in assessing material suitability for intended use. They have been developed from our own investigations as well as generally accessible publications. They do not represent any assurance for the properties themselves.

Unless expressly declared in writing, GGB gives no warranty that the products described are suited for any particular purpose or specific operating circumstances. GGB accepts no liability for any losses, damages, or costs however they may arise through direct or indirect use of these products.

GGB's sales and delivery terms and conditions, included as an integral part of quotations, stock and price lists, apply absolutely to all business conducted by GGB. Copies can be made available on request.

Products are subject to continual development. GGB retains the right to make specification amendments or improvements to technical data without prior announcement. Edition 2023 (this edition replaces earlier editions which hereby lose their validity).

STATEMENT REGARDING LEAD CONTENT IN GGB PRODUCTS & EU DIRECTIVE COMPLIANCE

GGB is committed to adhering to all U.S., European, and international standards and regulations with regard to lead content. We have established internal processes that monitor any changes to existing standards and regulations, and we work collaboratively with customers and distributors to ensure all requirements are strictly followed. This includes RoHS and REACH guidelines.

GGB makes it a top priority to operate in an environmentally conscious and safe manner. We follow numerous industry best practices and are committed to meeting or exceeding a variety of internationally recognized standards for emissions control and workplace safety.

Each of our global locations has management systems in place that adhere to IATF 16949, ISO 9001, ISO 14001, ISO 45001, and AS9100D/EN9100 quality regulations.

All of our certificates can be found here: <https://www.ggbearings.com/en/certificates>. A detailed explanation of our commitment to REACH and RoHS directives can be found at <https://www.ggbearings.com/en/who-we-are/quality-and-environment>



© 2023 GGB. All rights reserved.

GGB®, DP4, DP4-B, DU®, DU-B, DP10, DP11, DP31, DX®, DX®10, HI-EX®, DTS10®, DS, EP®, EP®12, EP®15, EP®22, EP®30, EP®43, EP®44, EP®63, EP®64, EP®73, EP®79, FLASH-CLICK®, KA Glacetal, Multilube, GAR-MAX®, GAR-FIL®, HSG, MLG, HPM, HPMB®, HPF®, GGB MEGALIFE® XT, Multifil, SBC with GAR-MAX®, SBC with HSG, GGB-CSM®, GGB-CBM®, GGB-BP25, GGB-FP20, GGB-SHB®, GGB-SO16, AuGlide™, SY, SP, GGB-DB®, UNI, MINI and EXALIGN™ are registered trademarks or trademarks, as the case may be, of GGB and its affiliates.

PUSHING BOUNDARIES TO CO-CREATE A HIGHER QUALITY OF LIFE



GGB NORTH AMERICA

700 Mid Atlantic Parkway | Thorofare, New Jersey, 08086 USA

Tel: +1-856-848-3200

<https://www.ggbearings.com/en>



HB300ENG08-23USA